

Model Specific

Dedicated accessories for Livestock • Horsebox
• Box Van • Commercial Trailers

Large cross division Page 109

Ramp gate extensions Page 114

Horsebox HB403, HB506 & HB511	Page
Mudguards & Rear Lamp Housing	86
HB511 Centre Partition	87
HB506 Centre Partition	88
Glazing, Ventilation & Seals	89
Rear Ramp Door Kits	90
Front Ramp Door Kits	91
Flooring & Matting	92
Tack Storage & Accessories	93
Trailer Covers & Decals	94

Horsebox HB510, HB505 & HB401	Page
Ramp & Door Fittings	95
Rear Ramp & Door Fittings	96
HB510 Centre Partition	97
HB505 Centre Partition	98
HB401 Breeching Bars	99
Flooring & Matting	100
Roof Sheets & Body Components	101 & 102
HB510XL & HB610	103
Livestock Centre Partitions	104

Livestock	Page
Ramp Spares & Corner Pillars	105
Body Panels, Drawbars & Extrusions	106 & 107
Small Cross Divisions	108
Large Cross Divisions	109
Single Height Cross Divisions	110
Cross Division Components	111
Sheep Deck Components	112
Guide to Rear Deck Barriers	113
Ramp Gates, Extensions & Back Rails	114
Sump Tanks & GRP Wind Deflectors	115

Commercial	Page
Dropside Kits LT/LM	116
Drawbars & Suspension Cross Members LT/LM	117
Headboards, Tailboards & Ladder Racks LT/LM	118
Ramps, Lighting Plates & Floor Capping LT/LM	119
Mesh Sides LT/LM/CT	120
Tipper Range – Spares and Accessories	121
Tipper Range – Mesh Sides	122
Tipper Range – Electrical & Battery Components	123

Commercial	Page
Tipper Range – Hydraulics	124
Tipper Range – Power packs	125
General Duty – Imperial range	126
General Duty – Metric range	127
P6E & P7E	128
BV64e & P5	129
P8E	130
CT177	131 & 132
CT136 & CT115	133
Box Van Range	134 & 135
GX84	136 & 137
GX85 & GX105	138
GX106 & GX106N	139
GX125HD & GX126	140
GP Range	141
GH Range	142
Eurolight Range	143
Canopy Doors & Spares	144

To order see pages 4&5 for distributor details or call 0845 4082 505. Prices available on separate Spares Pricelist



MUDGUARD AND REAR LAMP HOUSING

- 1 CP00321 Mudguard Twin Arch Sections. Fits either side.
- 2 CP00322 Mudguard Inner Section. Fits either side.
- 3 KX0286 Mudflaps. Per pair.
- 4 CP00324 Front Lamp Enclosure. Right Hand.
- 5 CP00323 Front Lamp Enclosure. Left Hand.
- 6 CP00326 Rear Corner Bumper. Right Hand HB403, HB506.
- 7 CP00325 Rear Corner Bumper. Left Hand HB403, HB506.
- 8 CP00328 Rear Corner Bumper. Right Hand HB511.
- 9 CP00327 Rear Corner Bumper. Left Hand HB511.
- 10 CP00392 Rear lamp Bezel.
- 11 F1245PK Mudguard/Bumper Polymate Screws. Pack of 60.

WHEELS, TYRES AND RELATED ITEMS

- 12 P08840 Wheel Trim. Sold Singly. Adds the finishing touch to standard steel wheels.
- 13 F1830PK Wheel Bolts. 4 pack – Standard non locking.
- 14 KX9802 Locking Wheel Bolt Kit. M12 x 1.5 pitch with uniquely coded adapter and spider wheel wrench. **Pack 4**
- 15 KX0240 Wheel Chocks. 1 Pair. Recommended for use when uncoupling, parking, and in place of the handbrake when storing your trailer for a length of time.
- 16 KX0795 Lockable Spare Wheel Carrier. Now positioned at the rear of the trailer. Enables you to fit a padlock for security.
- 17 P0885/SVR Spare Wheel Cover Silver. Fits the HB403, HB506, HB511, HB401, HB505 & HB510.
- 18 P1256 Wheel Brace. 19mm, for removing wheel bolts and for use with the quick release mechanism on the breast bar receiver eye bolt.



Model Specific

Centre Partition & Breast/Breeching Bars

HB511

Ifor Williams
Parts®

Page
87



- 1 WA00343 Breeching Bar. Half width for use with the centre partition.
- 2 KX0820 Full width Breeching Bar. For horses that prefer to travel in a wider stall. Centre partitions are removed and full width breast and breeching bars are fitted.
- 3 C31250 Breast/Breeching Bar Receiver Bracket. Fitted to the side wall of the trailer and to the partition leaves.
- 4 KS304714 Partition Leaf Assembly. (Front) Cream padding includes rubber skirt.
- 5 KS304514 Partition Leaf Assembly. (Rear) Cream padding includes rubber skirt.
- 6 C82544 Partition Skirt.
- 7 C00560 Partition Holding Hook.
- 8 WA00133 Partition Mounting Pole. For the HB511 mk1 (up to May 2011)
- WA00559 Partition Mounting Pole. For the HB511 mk2 (from May 2011 onwards)
- 9 CP00440 Partition Mounting Pole Clevis Pin.
- 10 F1913Z Partition Mounting Pole R Clip.
- 11 CP00441 Partition Mounting Pole Clevis Spring.
- 12 KX0805 Head Partition HB511. Also includes lower accessory tube and fittings.
- 13 P1022 Mini Tye. 135mm Centres (Head Partition).
- 14 P1025 Mini Tye. 225mm Centres (Head partition).
- 15 C00130 Fixing Pin for Head Partition.
- CP00447 Accessory Tube. For fitting head partition to the front panel.
- 16 F1103SVRPK Breast Bar Retaining Washers. (16 pack) silver.
- 17 F0932SVRPK Socket Head Screw. M8 x 35 (16 pack) Silver.
- 18 CP00436 Eye Bolt. M8 x 35mm Enables the release of breast bars safely from outside the trailer. Suits the wheel brace supplied with trailer.
- 19 P1278PK Neoprene Washer. 40mm washer used under the breast/breeching bar retainer washers.
- 20 P1260 Allen Key 5mm.
- 21 F1003ZPK Hexagon Nut M8. (Breast bar receivers – 20 pack).
- 22 F0923ZPK Socket Screw. M8 x 40 Cap Head. Used to secure the breast bar receiver bracket to the centre partition panel. Pack Qty 10.

To order see pages 4&5 for distributor details or call 0845 4082 505. Prices available on separate Spares Pricelist

To order see pages 4&5 for distributor details or call 0845 4082 505. Prices available on separate Spares Pricelist



- 1 WA00417 Breaching Bar. Half width for use with the centre partition.
- 2 KX0815 Full Width Breaching Bar. For horses that prefer to travel in a wider stall. Centre partitions are removed and full width breast and breeching bars are fitted.
- 3 C31250 Breast/Breeching Bar Receiver Bracket.
- 4 KS304814 Partition Leaf Assembly. (Front) Cream padding includes rubber skirt.
- 5 KS304614 Partition Leaf Assembly. (Rear) Cream padding includes rubber skirt.
- 6 C82543 Partition Skirt.
- 7 C00560 Partition Holding Hook.
- 8 WA00133 Partition Mounting Pole. For the HB506 mk1 (up to May 2011)
- WA00559 Partition Mounting Pole. For the HB506 mk2 (from May 2011 onwards)
- 9 CP00440 Partition Mounting Pole Clevis Pin.
- 10 F1913Z Partition Mounting Pole R Clip.
- 11 CP00441 Partition Mounting Pole Clevis Spring.
- 12 KX0800 Head Partition HB506. Also includes lower accessory tube and fittings.
- 13 P1022 Mini Tye. 135mm Centres (Head Partition).
- 14 P1025 Mini Tye. 225mm Centres (Head partition).
- 15 C00130 Fixing Pin for Head Partition.
- CP00447 Accessory Tube. For fitting head partition to the front panel.
- 16 F1103SVRPK Breast Bar Retaining Washers. (16 pack) silver.
- 17 F0932ARPK Socket Head Screw M8 x 35. (16 pack) silver.
- 18 CP00436 Eye Bolt. M8 x 35mm enables the release of breast bars safely from outside the trailer. Suits the wheel brace supplied with trailer.
- 19 P1278PK Neoprene Washer 40mm. 40mm washer used under the breast/breeching bar retainer washers. Pack Qty 16.
- 20 P1260 Allen Key 5mm.
- 21 F1003ZPK Hexagon Nut M8. (Breast bar receivers – 20 pack).
- 22 F0923ZPK Socket Screw. M8 x 40 Cap Head. Used to secure the breast bar receiver bracket to the centre partition panel. Pack Qty 10.

HB403

WA00454 Breaching Bar HB403.



SEALS, CAPPING & DRAUGHT EXCLUDERS

- 1 P1300-1036 Front Upper Door Seal. Silver HB403, HB506. Cut to correct length.
- 2 P1300-1193 Front Upper Door Sea. Silver HB511. Cut to correct length.
- 3 P1311-00688 Rear Door Beading. (vertical) HB403, HB506. Cut to correct length.
- 4 P1311-00703 Rear Door Beading. (vertical) HB511. Cut to correct length.
- 5 P1304-01205 Rear Door Surround Rubber HB403. Cut to correct length.
- 6 P1304-01365 Rear Door Surround Rubber HB506. Cut to correct length.
- 7 P1304-01430 Rear Door Surround Rubber HB511. Cut to correct length.
- 8 P1802 Inspection Door Seal. Per metre.
- 9 ET00078-01200 Pillar Capping. (external-rear). Cut to correct length.
- 10 ET00078-01600 Pillar Capping. (external-front). Cut to correct length.

WINDOWS, VENTS & GLAZING PARTS

- 11 CP00304 Front Window. Fitted to HB506 & HB511.
- 12 KX4325 Front Window Guard Kit. For the HB506 & HB511 mk2. The kit comprises of 1 guard, stiffener and rivets. Distributor supply & fit only.
- KS2278 Fixed Window Kit. (front top door) includes glass and rubber seal.
- 13 CP00281 Safety Glass. (Side Windows).
- 14 P1326 Glazing Rubber. (per metre) Thin panel.
- 15 P1327 Filler Strip. For above (per metre).
- 16 P1800 Glazing Rubber. (per metre) Timber panel.
- P1801 Filler Strip. For above (per metre).
- 17 P1212 Sliding Window.
- 18 P1212B Push Button. For sliding window.
- 19 KX4323 Window Protection Bars. (pair). For use when sliding windows fitted.
- 20 P1202 Roof (Nosecone) Pop-Up Ventilator HB403.
- 21 CP00365 Roof Ventilator Lid HB506, HB511.
- CP00366 Roof Ventilator Hinge HB506, HB511.
- 22 CP00367 Roof Vent Spring LH HB506, HB511.
- CP00368 Roof Vent Spring RH HB506, HB511.
- CP00369 Roof Vent Spring Bracket HB506, HB511.
- 23 CP00370 Roof Vent Spring Retainer HB506, HB511.

KICKBOARD & PADDING

- 24 CP00310 Kickboard. (lower side panel) HB403, HB506.
- 25 CP00311 Kickboard. (lower side panel) HB511.
- 26 CP00308-14 Padding. (side panel) Cream HB403, HB506.
- 27 CP00309-14 Padding. (side panel) Cream HB511.
- 28 CP00312 Padding End Retainer.



To order see pages 4&5 for distributor details or call 0845 4082 505. Prices available on separate Pricelist

To order see pages 4&5 for distributor details or call 0845 4082 505. Prices available on separate Spares Pricelist



RAMP & REAR DOOR SPARES

All rear door kits are supplied with hinges, release toggles and fittings.

1	C31249	Ramp Closure Handle.
2	P00165	Bolt Head Cover. (silver-grey for ramp handle).
3	WA00052	Front Ramp Hinge Assembly.
4	CP00172	Front Body Grab Handle. Nylon moulded pull handle.
	CP00173	Top Door Retainer Pin. Used to secure the front and rear doors in the open position.
5	CP00415	Buffer – Upper Door Retainer. Used with CP00173
6	WA00157	Upper Door Hinge Assembly. (rear – long offset).
7	WA00158	Upper Door Hinge Assembly. (side – short offset). Also used on the inspection door.
8	WA00166	Upper Door Retainer Release Assembly.
9	WA00171	Upper Door Release Toggle/Slider Assembly.
10	P1191	Gas Spring. (Front and rear ramp).
11	P1192	Gas Spring Cover.
12	P1228	Ramp Guide. (Rear ramp – all models).
13	CP00348	Ramp Guide. (front ramp – all models).
14	C00150	Ramp Latch Staple. (Rear ramp – all models).
15	CP00091	Ramp Latch Staple. (front ramp – all models).
	CP00446	Barrel Nut. (Rear Ramp Latch Staple).
16	P1803	Inspection Door Lock. (outer) assembly.
17	WA00460	Inspection Door Latch. (inner) assembly.
	CP00399	Inspection Door Lock Keeper.

REAR RAMP DOOR KITS

All rear door kits are supplied with hinges, release toggles & fittings.

KS3080L-01B	Rear Door.	Left hand HB403 Silver.
KS3080R-01B	Rear Door.	Right hand HB403 Silver.
KS3080L-03B	Rear Door.	Left hand HB403 Green.
KS3080R-03B	Rear Door.	Right hand HB403 Green.
KS3080L-04B	Rear Door.	Left hand HB403 Red.
KS3080R-04B	Rear Door.	Right hand HB403 Red.
KS3080L-06B	Rear Door.	Left hand HB403 Blue.
KS3080R-06B	Rear Door.	Right hand HB403 Blue.
KS3080L-08A	Rear Door.	Left hand HB403 Black.
KS3080R-08A	Rear Door.	Right hand HB403 Black.
KS3080L-12B	Rear Door.	Left hand HB403 Graphite.
KS3080R-12B	Rear Door.	Right hand HB403 Graphite.
KS3081L-01B	Rear Door.	Left hand HB506 mk2 Silver.
KS3081R-01B	Rear Door.	Right hand HB506 mk2 Silver.
KS3081L-03B	Rear Door.	Left hand HB506 mk2 Green.
KS3081R-03B	Rear Door.	Right hand HB506 mk2 Green.
KS3081L-04B	Rear Door.	Left hand HB506 mk2 Red.
KS3081R-04B	Rear Door.	Right hand HB506 mk2 Red.
KS3081L-06B	Rear Door.	Left hand HB506 mk2 Blue.
KS3081R-06B	Rear Door.	Right hand HB506 mk2 Blue.
KS3081L-08A	Rear Door.	Left hand HB506 mk2 Black.
KS3081R-08A	Rear Door.	Right hand HB506 mk2 Black.
KS3081L-12B	Rear Door.	Left hand HB506 mk2 Graphite.
KS3081R-12B	Rear Door.	Right hand HB506 mk2 Graphite.
KS3082L-01B	Rear Door.	Left hand HB511 mk2 Silver.
KS3082R-01B	Rear Door.	Right hand HB511 mk2 Silver.
KS3082L-03B	Rear Door.	Left hand HB511 mk2 Green.
KS3082R-03B	Rear Door.	Right hand HB511 mk2 Green.
KS3082L-04B	Rear Door.	Left hand HB511 mk2 Red.
KS3082R-04B	Rear Door.	Right hand HB511 mk2 Red.
KS3082L-06B	Rear Door.	Left hand HB511 mk2 Blue.
KS3082R-06B	Rear Door.	Right hand HB511 mk2 Blue.
KS3082L-08A	Rear Door.	Left hand HB511 mk2 Black.
KS3082R-08A	Rear Door.	Right hand HB511 mk2 Black.
KS3082L-12B	Rear Door.	Left hand HB511 mk2 Graphite.
KS3082R-12B	Rear Door.	Right hand HB511 mk2 Graphite.
KX0811-1	Rear Doors.	1 pair HB506 mk1 Silver.
KX0811-4	Rear Doors.	1 pair HB506 mk1 Red.
KX0811-6	Rear Doors.	1 pair HB506 mk1 Blue.
KX0811-8	Rear Doors.	1 pair HB506 mk1 Black.
KX0811-12	Rear Doors.	1 pair HB506 mk1 Graphite.
KX0812-1	Rear Doors.	1 Pair HB511 mk1 Silver.
KX0812-4	Rear Doors.	1 Pair HB511 mk1 Red.
KX0812-6	Rear Doors.	1 Pair HB511 mk1 Blue.
KX0812-8	Rear Doors.	1 Pair HB511 mk1 Black.
KX0812-12	Rear Doors.	1 Pair HB511 mk1 Graphite.

FRONT RAMP DOORS MK1 & MK2

KS2272-01B	HB511 Front Ramp Top Door Left Hand (Excluding Window) Silver. Includes hinges and fastenings.
KS2270-01B	HB511 Front Ramp Top Door Right Hand (Excluding Window) Silver. Includes hinges and fastenings.
KS2272-03B	HB511 Front Ramp Door Left Hand (Excluding Window) Green. Includes hinges and fastenings.
KS2270-03B	HB511 Front Ramp Door Right Hand (Excluding Window) Green. Includes hinges and fastenings.
KS2272-04B	HB511 Front Ramp Top Door Left Hand (Excluding Window) Red. Includes hinges and fastenings.
KS2270-04B	HB511 Front Ramp Top Door Right Hand (Excluding Window) Red. Includes hinges and fastenings.
KS2272-06B	HB511 Front Ramp Top Door Left Hand (Excluding Window) Blue. Includes hinges and fastenings.
KS2270-06B	HB511 Front Ramp Top Door Right Hand (Excluding Window) Blue. Includes hinges and fastenings.
KS2272-08A	HB511 Front Ramp Top Door Left Hand (Excluding Window) Black. Includes hinges and fastenings.
KS2270-08A	HB511 Front Ramp Top Door Right Hand (Excluding Window) Black. Includes hinges and fastenings.
KS2272-12B	HB511 Front Ramp Top Door Left Hand (Excluding Window) Graphite. Includes hinges and fastenings.
KS2270-12B	HB511 Front Ramp Top Door Right Hand (Excluding Window) Graphite. Includes hinges and fastenings.

KS2276-01B	HB506/HB403 Front Ramp Top Door Left Hand (Excluding Window) Silver. Includes hinges and fastenings.
KS2274-01B	HB506/HB403 Front Ramp Top Door Right Hand (Excluding Window) Silver. Includes hinges and fastenings.
KS2276-03B	HB506/HB403 Front Ramp Door Left Hand (Excluding Window) Green. Includes hinges and fastenings.
KS2274-03B	HB506/HB403 Front Ramp Door Right Hand (Excluding Window) Green. Includes hinges and fastenings.
KS2276-04B	HB506/HB403 Front Ramp Top Door Left Hand (Excluding Window) Red. Includes hinges and fastenings.
KS2274-04B	HB506/HB403 Front Ramp Top Door Right Hand (Excluding Window) Red. Includes hinges and fastenings.
KS2276-06B	HB506/HB403 Front Ramp Top Door Left Hand (Excluding Window) Blue. Includes hinges and fastenings.
KS2274-06B	HB506/HB403 Front Ramp Top Door Right Hand (Excluding Window) Blue. Includes hinges and fastenings.
KS2276-08A	HB506/HB403 Front Ramp Top Door Left Hand (Excluding Window) Black. Includes hinges and fastenings.
KS2274-08A	HB506/HB403 Front Ramp Top Door Right Hand (Excluding Window) Black. Includes hinges and fastenings.
KS2276-12B	HB506/HB403 Front Ramp Top Door Left Hand (Excluding Window) Graphite. Includes hinges and fastenings.
KS2274-12B	HB506/HB403 Front Ramp Top Door Right Hand (Excluding Window) Graphite. Includes hinges and fastenings.



FLOOR & RAMP MATTING

- 1** CP00116 **Floor Matting.** Ribbed rubber mat pre-cut to fit The HB511 mk2.
- CP00115 **Floor Matting.** Ribbed rubber mat pre-cut to fit the HB506 mk2.
- CP01113 **Rubber Strip.** Used when fitting CP00115 & CP00116 to the mk1 trailers.
- CP00223 **Floor Matting.** Ribbed rubber matting pre-cut to fit HB403 suitable for either right or left hand side front ramp.
- CP00277 **Rear Ramp Matting.** High grip rubber matting pre-cut to fit HB511.
- CP00275 **Rear Ramp Matting.** High grip rubber matting pre-cut to fit HB506.
- CP00273 **Rear Ramp Matting.** High grip rubber matting pre-cut to fit HB403.
- CP00276 **Front Ramp Matting.** High grip rubber matting pre-cut to fit HB511.
- CP00274 **Front Ramp Matting.** High grip rubber matting pre-cut to fit HB506 & HB403.

ALUMINIUM FLOORS

Suitable for either right or left hand side front ramps

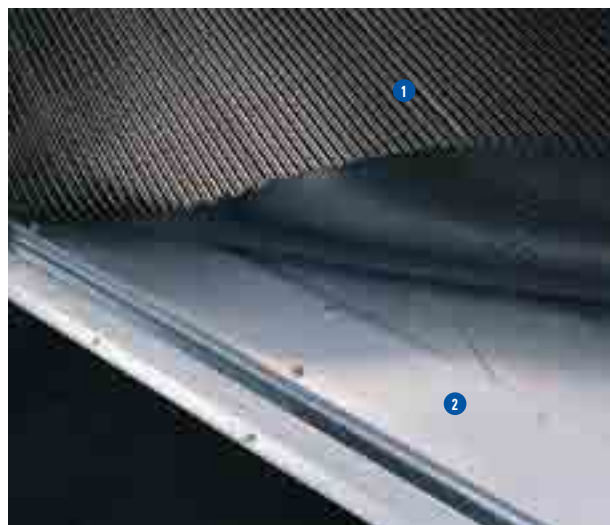

- 2** WA00114 **Aluminium Floor Kit.** Pre formed aluminium floor and finisher strips to fit the HB511 mk2. Can also be fitted to the HB511 mk1 when CP01008 floor trim is used.
- WA00113 **Aluminium Floor Kit.** Pre formed aluminium floor and finisher strips to fit the HB506 mk2. Can also be fitted to the HB506 mk1 when CP01008 floor trim is used.
- CP01008 **Floor Trim.** Required when fitting WA00114 & WA00113 aluminium floors to the HB511 mk1 & HB506 mk1.
- WA00220 **Aluminium Floor Kit.** Pre formed aluminium floor and finisher strips to fit HB403.
- KS27230 **Floor Matting Retaining Hardware Set.** Set of 4 Staples with fixing hardware.



Model Specific

Spare Parts List HB403, HB506 & HB511

TACK STORAGE

-  **1 KX01251 Removable Tack Pack silver.** Removable storage unit for the HB505, HB510, HB506 & HB511 series, includes galvanized Saddle rack, removable feed bowl and lockable front fasteners.
- 2 P0448 Tack Pack Wheel.** Replacement wheel for Tack Pack units.
- 3 P0449 Axle.** Replacement axle to fit the Tack Pack unit.
- 4 B0102A Elastic Strap.** 32" long.
- B0102B Elastic Strap.** 36" long.
- B0102C Elastic Strap.** 42" long.
- P1266 Staple Checkstrap.** Used with elastic straps to secure the Removable Tack Pack.
-  **5 KX012414 Door Mounted Tack Pack Cream.** Attached to the grooms door, suitable for the HB403, HB506 & HB511. This neat storage solution is capable of storing two saddles and various tack. Suitable for General Purpose saddles up to 17" (43cm). We advise that you check saddles fit prior to purchase.
- 6 KX01231 Fastening Kit.** (Door mounted Tack Pack) Silver.

ACCESSORIES

- 7 KX0830 Mesh Internal Storage Pouch.** Ideal for storing trailer manuals and other small items such as hair brushes etc.
- B0167 Trailer-Camera. Wireless Camera System.** Transmits live colour footage from the trailer interior to the towing vehicle, enables passengers to monitor the horse during transit. The camera can be powered from a battery pack or trailer lighting system.
- 8 B0163 Grooms Door Vanity Mirror.** A choice of where it can be positioned within the trailer.
- 9 KX0233 Prop Stand Kit.** Consider prop stands if your horse requires a particularly steady surface to load. Additional support will reassure nervous horses.



To order see pages 4&5 for distributor details or call 0845 4082 505. Prices available on separate Spares Pricelist

To order see pages 4&5 for distributor details or call 0845 4082 505. Prices available on separate Spares Pricelist

Trailer Covers

- | | |
|---|---|
| 1 B01686L | Trailer Cover HB403 / HB401. For models with a left hand side inspection door. Blue |
| B01686R | Trailer Cover HB403 / HB401. For models with a right hand side inspection door. Blue |
| B01696L | Trailer Cover HB506 / HB505. For models with a left hand side inspection door. Blue |
| B01696R | Trailer Cover HB506 / HB505. For models with a right hand side inspection door. Blue |
| B01706L | Trailer Cover HB510 / HB511. For models with a left hand side inspection door. Blue |
| B01706R | Trailer Cover HB510 / HB511. For models with a right hand side inspection door. Blue |
| Trailer Aid. Used when replacing a flat or punctured tyre. Saves time and energy no need to use a jack. Available in black and yellow. | |
| 2 B0054 | Black. |
| B0055 | Yellow. |



Model Specific

Horsebox Pre-April 2008 HB510, HB505 & HB401 Ramp & Door Fittings

- 1 C40510 Door Panel HB510. Front ramp door panel White, with hole for sliding window.
- C40510-SVR Door Panel HB510. Front ramp door panel Silver, with hole for sliding window
- C40531 Door Panel HB510. Front ramp door panel White, with hole for fixed window.
- C40531-SVR Door Panel HB510. Front ramp door panel Silver, with hole for fixed window.
- C49277 Door Panel HB505. Front ramp door panel White, plain panel.
- C40555 Door Panel HB505. Front ramp door panel White, hole for sliding window.
- C40555-SVR Door Panel HB505. Front ramp door panel Silver, hole for sliding window.
- C40539 Door Panel HB401. Front ramp door panel White, hole for fixed window.
- C40539-SVR Door Panel HB401. Front ramp door panel Silver, hole for fixed window
- C40511 Over Inspection Door Panel HB510. White with hole for sliding window.
- C40511-SVR Over Inspection Door Panel HB510. Silver with hole for sliding window.
- C40533 Over Inspection Door Panel HB510. White with hole for fixed window.
- C40533-SVR Over Inspection Door Panel HB510. Silver with hole for fixed window.
- C40556 Over Inspection Door Panel HB505. White.
- C40556-SVR Over Inspection Door Panel HB505. Silver.
- C40538 Over Inspection Door Panel HB401. White with hole for a fixed window.
- C40538-SVR Over Inspection Door Panel HB401. Silver with hole for a fixed window.
- 2 C11149SS Door Pull. Combined antiluce plate and door pull for door over front ramp (Stainless Steel).
- 3 C11154 Hinge. Cranked hinge used on the door over the side ramp (Stainless Steel).
- 4 P1302 Door Seal. Horsebox rigid double lipped door seal 1705mm.
- 5 P1228 Ramp Guide. Allows the ramp to sit correctly in its aperture and prevents sideways movement.
- 6 P1247 Ramp Guide. Similar to P1228 but with no back stop.
- AS4108 Ramp Hinge. Front bolt on ramp hinge for HB401, 505 & 510.
- 7 P1246 Ramp Pivot Bush. Used on the ramp and chassis hinge points.
- C20938 Ramp Hinge Tube. Nylon coated.
- 8 P1194 End Cap. Used on the older flat ramp handles.
- 9 P11190 Pin & Chain. For the front and rear ramp latches.
- 10 P1191 Gas Spring. For the front ramp on HB401, 505 & 510 models.
- 11 P1192 Bellows. Front ramp gas spring bellows for HB401, 505 & 510 (From 1992).
- 12 C00150 Staple. 50mm long ramp catch staple. (Front ramp).
- 13 C00151 Staple. 75mm long ramp catch staple. (Rear ramp).
- 14 P1004 Antiluce Fastener. Used on HB401, HB505 & HB510.
- 15 C10617SS Door pull. Combined antiluce plate and door pull used on horsebox inspection doors (Stainless Steel).
- 16 P1051 Grab Handle. Front panel.
- 17 P1072SS Hinge. Inspection door hinge for horsebox models HB401, 505 & 510 (Stainless Steel).
- 18 C31249 Ramp Closure Handle. Used on the front and rear ramp.
- C10860 Rear Pillar. Right hand HB510.
- C10861 Rear Pillar. Left hand HB510.
- C10862 Rear Pillar. Right hand HB505/HB401.
- C10863 Rear Pillar. Left hand HB505/HB401.
- C15307 Number Plate Backing Panel.



To order see pages 4&5 for distributor details or call 0845 4082 505. Prices available on separate Spares Pricelist

To order see pages 4&5 for distributor details or call 0845 4082 505. Prices available on separate Spares Pricelist



- 1 KS3001 Rear Doors.** A pair of rear doors to fit the HB505 (kit includes hinges and retainer plates).
- KS3004 Rear Doors.** A pair of rear doors to fit the HB510 (kit includes hinges and retainer plates).
- KS3006 Rear Doors.** A pair of rear doors to fit the HB401 (kit includes hinges and retainer plates).
- 2 C00831 Door Retainer Plate.** Secures rear door in the open position.
- 3 P1110/50SS Linch Pin.** 1/4" shaft diameter 50mm long stainless steel.
- 4 C11155 Hinge.** Rear door hinge for Horsebox models HB401, 505 & 510 (Stainless Steel).
- 5 P1311 Edge Beading.** Black with steel insert. Vertical trim (per metre).
- 6 P1304 Rubber Seal.** Outer seal for the rear doors (per metre).
- 7 AS0630SS Linch Pin Receiver.** Used for holding rear doors in the open position (Stainless Steel).
- 8 P1330/30 Neoprene Tube.** This small tube is fitted to the outer door retainers to act as a buffer for the antiluce plate.
- 9 P1111 Linch Pin Receiver.** Weld on replacement, used to secure rear doors to horsebox ramp.



Model Specific

Horsebox Pre-April 2008

Centre Partition

HB510

Ifor Williams

Parts

Page
97

These silver partitions can also be used to replace the coloured partitions in trailers manufactured since January 1999, both types are fully interchangeable with the head partitions.

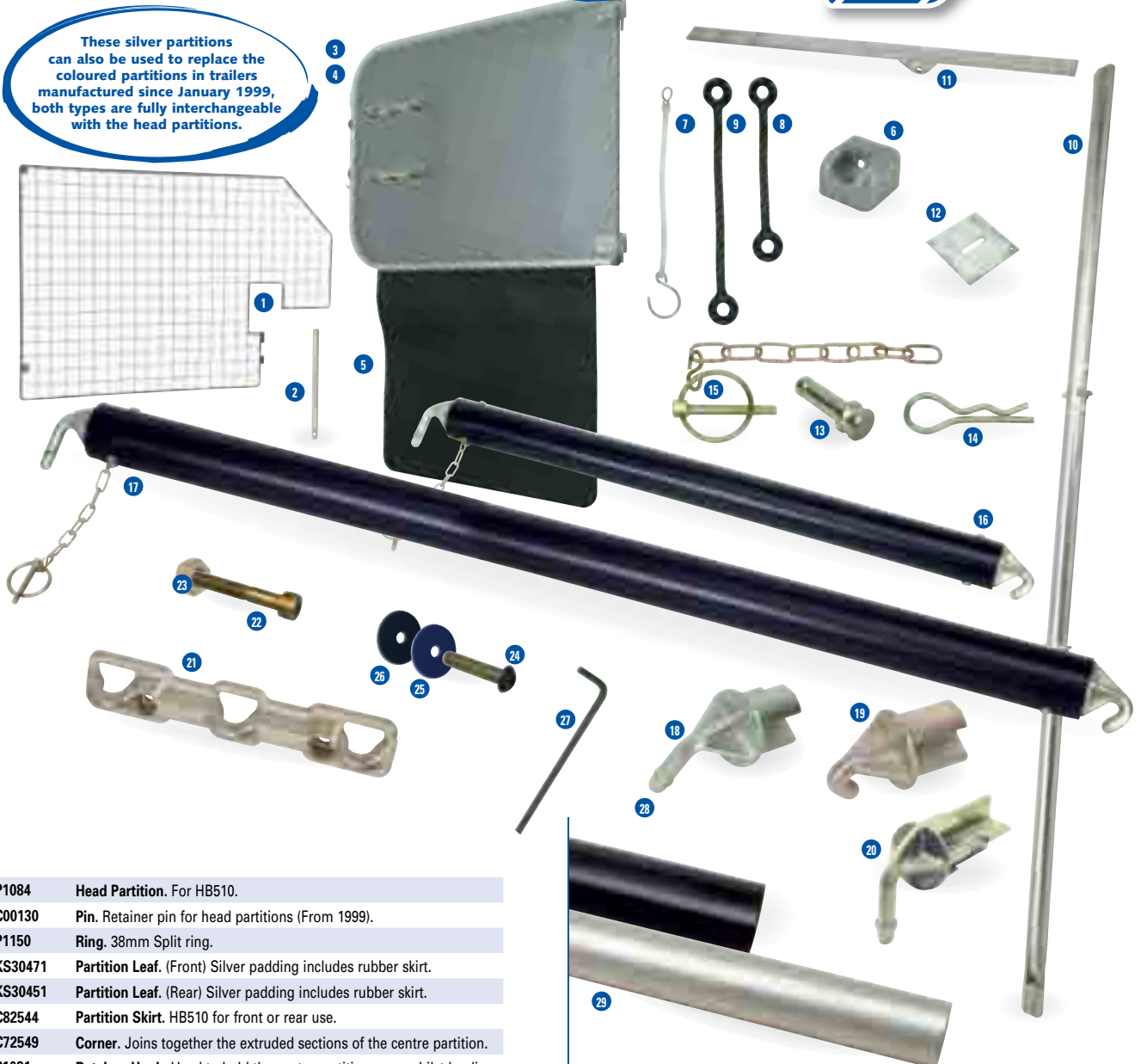

- 1 P1084 **Head Partition.** For HB510.
- 2 C00130 **Pin.** Retainer pin for head partitions (From 1999).
P1150 **Ring.** 38mm Split ring.
- 3 KS30471 **Partition Leaf.** (Front) Silver padding includes rubber skirt.
- 4 KS30451 **Partition Leaf.** (Rear) Silver padding includes rubber skirt.
- 5 C82544 **Partition Skirt.** HB510 for front or rear use.
- 6 C72549 **Corner.** Joins together the extruded sections of the centre partition.
- 7 P1021 **Retainer Hook.** Used to hold the centre partition open whilst loading.
- 8 P1022 **Mini Tye.** Soft rubber used on horsebox head partitions or for general holding and tie back. 135mm centres.
- 9 P1025 **Mini Tye.** Longer version. 225mm centres.
- 10 AS7590 **Centre Pillar.** HB510 - the type used from January 1999.
- 11 AS7509 **Fixing Bracket.** HB510 - Fixes the centre partition pole to the trailer roof.
- 12 C11153 **Fixing Bracket.** Used where centre partition pole enters the floor.
- 13 C00077 **Clevis Pin.** Used to secure the centre partition pole to the upper bracket (HB505/510 or TA5 models with horse kit).
- 14 F1913Z **R Clip.** Holds the centre partition clevis securely in place.
- 15 P1110/50SS **Linch Pin.** 1/4 inch diameter linch pin and snap ring with retainer chain fitted (50mm pin). Stainless steel.
- 16 KS27218 **Breast/Breeching Bar.** For HB510 (Black).
- 17 KX01168 **Breast/Breeching Bar Full Length.** For horses that prefer to travel in a wider stall. Centre partitions are removed and full width breast and breeching bars are fitted.
- 18 C31253 **Pin End.** Pin end casting for breast/breeching bars.
- 19 C31252 **Hook End.** Hook end casting for breast/breeching bars.
- 20 C31259 **Pin End (Sliding).** Pin end casting for full width breeching bars.
- 21 C31250 **Receiver Bracket.** Three hole breeching bar receiver bracket.
- 22 F0923ZPK **Socket Screw.** M8 x 40 Cap head. Used to secure the breast bar bracket to the centre partition panel. **Pack 10**
- 23 F1003ZPK **Nut.** M8 Plain hex type. **Pack 20**

- 24 F0932ZPK-04A **Socket Screw.** This M8x35 button head screw retains the breast/breeching bar receiver bracket from the outside of the trailer (Red). **Pack 16**
- F0932ZPK-03A **Socket Screw.** Green. **Pack 16**
- F0932ZPK-06A **Socket Screw.** Blue. **Pack 16**
- F0932ZPK-01B **Socket Screw.** Silver. **Pack 16**
- F0932ZPK-08A **Socket Screw.** Black. **Pack 16**
- 25 F1103ZPK-04A **Retainer Washer.** This washer sits under the breast/breeching bar receiver bolt on the outside of the trailer (Red). **Pack 16**
- F1103ZPK-03A **Retainer Washer.** Green. **Pack 16**
- F1103ZPK-06A **Retainer Washer.** Blue. **Pack 16**
- F1103ZPK-01B **Retainer Washer.** Silver. **Pack 16**
- F1103ZPK-08A **Retainer Washer.** Black. **Pack 16**
- 26 P1278PK **Neoprene Washer.** 40mm washer used under the breast/breeching bar retainer washers. **Pack 16**
- 27 P1260 **Hex key.** For the Horsebox breast/breeching bar release system on HB401, 505 & 510.
- 28 P13292/8 **Breast/Breeching Bar Cover.** 766mm cover for breast/breeching bars (Black).
- 29 C498860 **Breast/Breeching Bar Tube.** For HB510. Length 757mm.
KS2720 **Breast/Breeching Bar.** Plain aluminium type used till Jan'99. Length of tube 785.5mm.

To order see pages 4&5 for distributor details or call 0845 4082 505. Prices available on separate Spares Pricelist

These silver partitions can also be used to replace the coloured partitions in trailers manufactured since January 1999, both types are fully interchangeable with the head partitions.



- 1 P1085 Head Partition. For HB505.
- 2 C00130 Pin. Retainer pin for head partitions (From 1999).
P1150 Ring. 38mm Split ring.
- 3 KS30481 Partition Leaf. (Front) Silver padding includes rubber skirt.
- 4 KS30461 Partition Leaf. (Rear) Silver padding includes rubber skirt.
- 5 C82543 Partition Skirt. HB505 for front or rear use.
- 6 C72549 Corner. Joins together the extruded sections of the centre partition
- 7 P1021 Retainer Hook. Used to hold the centre partition open whilst loading.
- 8 P1022 Mini Tye. Soft rubber version used on horsebox head partitions or for general holding and tie back applications. (135mm centres)
- 9 P1025 Mini Tye. Longer version with 225mm centres.
- 10 AS7585 Centre Pillar. HB505 - the type used since January 1999.
- 11 AS7459 Fixing Bracket. HB505 - Fixes the centre partition pole to the trailer roof.
- 12 C11153 Fixing Bracket. Used where centre partition pole enters the floor.
- 13 C00077 Clevis Pin. Used to secure the centre partition pole to the upper bracket (HB505/510 or TA5 models with horse kit).
- 14 F1913Z R Clip. Holds the centre partition clevis securely in place.
- 15 P1110/50SS Linch Pin. 1/4 inch diameter linch pin and snap ring with retainer chain fitted (50mm pin). Stainless steel.
- 16 KS26968 Breast/Breaching Bar. HB505 plastic covered (Black).
- 17 KX01158 Breast/Breaching bar full length. For horses that prefer to travel in a wider stall. Centre partitions are removed and full width breast and breaching bars are fitted.
- 18 C31253 Pin End. Pin end casting for breast/breaching bars.
- 19 C31252 Hook End. Hook end casting for breast/breaching bars.
- 20 C31259 Pin End (Sliding). Pin end casting for full width bars.
- 21 C31250 Receiver Bracket. Three hole cast receiver bracket.
- 22 F0923ZPK Socket Screw. M8 x 40 Cap head. Used to secure the breast bar bracket to the centre partition panel. Pack 10
- 23 F1003ZPK Nut. M8 Plain hex type. Pack 20

- 24 F0932ZPK-04A Socket Screw. This M8x35 button head screw retains the breast/breaching bar receiver bracket from the outside of the trailer (Red). Pack 16
- F0932ZPK-03A Socket Screw. Green. Pack 16
- F0932ZPK-06A Socket Screw. Blue. Pack 16
- F0932ZPK-01B Socket Screw. Silver. Pack 16
- F0932ZPK-08A Socket Screw. Black. Pack 16
- 25 F1103ZPK-04A Retainer Washer. This washer sits under the breast/breaching bar receiver bolt on the outside of the trailer (Red). Pack 16
- F1103ZPK-03A Retainer Washer. Green. Pack 16
- F1103ZPK-06A Retainer Washer. Blue. Pack 16
- F1103ZPK-01B Retainer Washer. Silver. Pack 16
- F1103ZPK-08A Retainer Washer. Black. Pack 16
- 26 P1278PK Neoprene Washer. 40mm washer used under the breast/breaching bar retainer washers. Pack 16
- 27 P1260 Hex Key. For the Horsebox breast/breaching bar release system on HB401, 505 & 510.
- 28 P13294/8 Breast/Breaching Bar Cover. 705mm cover (Black).
- 29 C498870 Breast/Breaching Bar Tube. 698.0mm aluminium section.
KS2695 Breast/Breaching Bar. HB505 Plain aluminium type used till Jan'99. Length of tube 724.5mm.

Model Specific
Horsebox Pre-April 2008
Breeching Bars

HB401

Ifor Williams
Parts®

Page
99



**For details of end fittings
and breast bar receivers see
HB505/510 section**

- 1 KS26858 Breeching Bar. HB401.
- 2 P13296/8 Breeching Bar Cover. HB401. Length of cover 1110.5mm.
- 3 C49885 Breeching Bar Tube. HB401. Length of tube 1110.5mm.

To order see pages 4&5 for distributor details or call 0845 4082 505. Prices available on separate Spares Pricelist



HB505 double horsebox

KICKBOARD PANELS

- 1 C79015 Kickboard. LH Kickboard for HB510 (1999 on).
- C79016 Kickboard. RH Kickboard for HB510 (1999 on).
- C79018 Kickboard. LH Kickboard for HB505 (1999 on).
- C79019 Kickboard. RH Kickboard for HB505 (1999 on).

FLOOR & REAR RAMP MATTING

- C80810 Floor Matting. Ribbed rubber matting pre cut to fit HB401.
- 2 C80812 Floor Matting. Ribbed rubber matting pre cut to fit HB505 Basic (No front ramp) and HB505 pre 1992.
- C80814 Floor Matting. Ribbed rubber matting pre cut to fit HB505 (Post 1992).
- C80816 Floor Matting. Ribbed rubber matting pre cut to fit HB510.
- C89031 Floor Matting. 10mm patterned rubber matting 2000mm x 1000mm. Used on older horse trailers (pre 99).
- C890454 Ramp Matting. High grip rubber matting pre cut to fit HB505 Rear ramp 1520mm x 1508mm x 6mm.
- C890452 Ramp Matting. High grip rubber matting pre cut to fit the HB401 rear ramp. 1520mm x 1093mm x 6mm.
- C890455 Ramp Matting. High grip rubber matting pre cut to fit HB510 Rear ramp. 1520mm x 1615mm x 6mm
- 3 C890460 Ramp Matting. High grip rubber matting pre cut to fit the container rear ramp. 2050mm x 1770mm x 6mm.
- 4 KS27230 Floor Mat Fixing - set of 4. Staples with fixing hardware.



- 5 C49781 Corner Moulding. 990mm. Used to secure the front ramp matting on the HB401/HB505. Horizontal.
- C49765 Corner Moulding. 1150mm. Used to secure the front ramp matting on the HB510. Horizontal.
- C49782 Corner Moulding. 1098mm. Used to secure the rear ramp matting on the HB401. Horizontal.
- C49769 Corner Moulding. 1513mm. Used to secure the rear ramp matting on the HB505. Horizontal.
- C49779 Corner Moulding. 1620mm. Used to secure the rear ramp matting on the HB510. Horizontal.
- C497635 Square Corner Moulding. 1524mm. Used to secure front and rear ramp matting on the HB401, HB505 & HB510. Vertical.

FRONT RAMP MATTING

- 6 C890451 Ramp Matting. High grip rubber matting pre cut to fit HB401/505 Front ramp 1520mm x 983mm x 6mm.
- C890453 Ramp Matting. High grip rubber matting pre cut to fit HB510 Front ramp 1520mm x 1140mm x 6mm.
- C890461 Ramp Matting. High grip rubber matting for horsebox container front ramp 1420 x 1140 x 6mm.



ALUMINIUM FLOOR KITS

- 7 KS0700 Aluminium Floor Kit. Pre formed aluminium floor and finsher strips, to fit HB505 (Pre 1992).
- KS0705 Aluminium Floor Kit. Pre formed aluminium floor and finsher strips, to fit HB401.
- KS0711 Aluminium Floor Kit. Pre formed aluminium floor and finsher strips, to fit HB505 (Post 1992).
- KS0714 Aluminium Floor Kit. Pre formed aluminium floor and finsher strips, to fit HB505 Basic (No front ramp).
- KS0720 Aluminium Floor Kit. Pre formed aluminium floor and finsher strips, to fit HB510.

Model Specific

Horsebox Pre-April 2008 HB510, HB505 & HB401 Roof Sheets, Channels & Body Parts

ALUMINIUM ROOF SHEETS

C49278	White Aluminium Roof Sheet. HB401.
C49278-SVR	Silver Aluminium Roof Sheet. HB401.
C49275	White Aluminium Roof Sheet. HB505.
C49275-SVR	Silver Aluminium Roof Sheet. HB505.
C49270	White Aluminium Roof Sheet. HB510.
C49270-SVR	Silver Aluminium Roof Sheet. HB510.

GRP ROOF SECTIONS

C72440	White GRP Roof Section. HB401.
C72440/SILVER	Silver GRP Roof Section. HB401.
C72421	White GRP Roof Section. HB505.
C72421/SILVER	Silver GRP Roof Section. HB505.
C72430	White GRP Roof Section. HB510.
C72430/SILVER	Silver GRP Roof Section. HB510.

FRONT STUCCO ALUMINIUM PANELS

C40542	Front Panel. HB401.
C40541	Front Panel. HB505.
C40540	Front Panel. HB510.

ROOF CHANNELS

C19346	Roof Channel. HB401.
C19303	Roof Channel. HB505.
C19345	Roof Channel. HB510.

ROOF CHANNEL COVERS

P1322	Roof Channel Cover. White, snap in plastic 6334mm.
P1322/BLACK	Roof Channel Cover. Black, snap in plastic 6334mm.

FRONT & REAR RAMP PILLARS

C10860	Rear Ramp Pillar. HB510 Right hand.
C10861	Rear Ramp Pillar. HB510 Left hand.
C10862	Rear Ramp Pillar. HB505/401 Right hand.
C10863	Rear Ramp Pillar. HB505/401 Left hand.
C10841	Front Ramp Pillar. HB510 Right hand – nearest front of trailer.
C10842	Front Ramp Pillar. HB510 Left hand – nearest rear of trailer.
C10831	Front Ramp Pillar. HB505/401 Right hand – nearest front of trailer.
C10832	Front Ramp Pillar. HB505/401 Left hand – nearest rear of trailer.

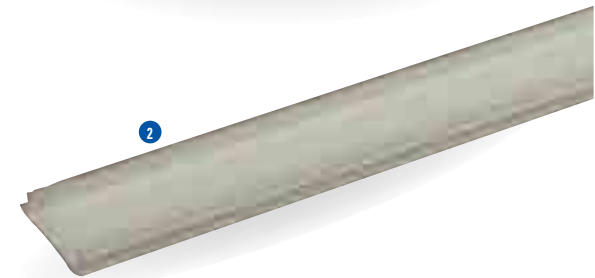
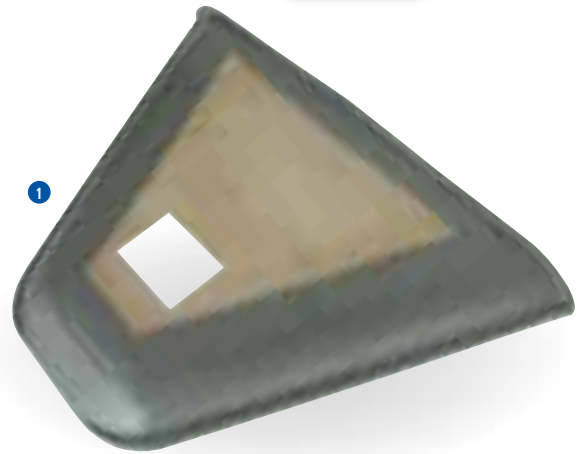

To order see pages 4&5 for distributor details or call 0845 4082 505. Prices available on separate Spares Pricelist

HB505 double horsebox

Model Specific

Horsebox Pre-April 2008 HB510, HB505 & HB401

Padding, Glazing, Light Brackets & Foot Plates

To order see pages 4&5 for distributor details or call 0845 4082 505. Prices available on separate Spares Pricelist

COMPOSITE PADDING POLYPROPYLENE/FOAM

Polypropylene side padding material with built in foam cushioning in pearlescent silver, as fitted to the interior side panels of our horseboxes.

C79243/1	Composite Padding. PP SHEET/FOAM 1 x 735 x 2070mm HB401/505 Right hand side.
C79244/1	Composite Padding. PP SHEET/FOAM 1 x 735 x 2515mm HB401/505 Left hand side.
C79246/1	Composite Padding. Silver PP SHEET/FOAM 735mm x 2292mm HB510 Right hand.
C79247/1	Composite Padding. Silver PP SHEET/FOAM 735mm x 2890mm HB510 Left hand.



RETAINER BARS

C49450	Padding Retainer. 2070mm Twin lipped extrusion Right hand used between padding and kickboard on HB401 & 505.
C49460	Padding Retainer. 2292mm Twin lipped extrusion Right hand used between padding and kickboard on HB510.
C49455	Padding Retainer. 2515mm Twin lipped extrusion Left hand used between padding and kickboard on HB401 & 505.
C49465	Padding Retainer. 2890mm Twin lipped extrusion Left hand used between padding and kickboard on HB510.



GLAZING & VENTILATION

1	P1213	Safety Glass. Safety glass 360 x 230mm Approx, as fitted to horseboxes.
2	P1326	Glazing Rubber. As used on horsebox front windows, requires filler strip to finish.*
3	P1327	Filler Strip. Holds the glass securely in place within the main rubber.*
4	P1202	Vent. As used in the roof of the HB401, HB403, HB505 & HB510 Black lid with a Silver frame.



LIGHT BRACKETS

5	C11280	Light Bracket. Right hand HB510, HB505 & HB401
	C11281	Light Bracket. Left hand HB510, HB505 & HB401

FOOT PLATES

6	C11400	Footplate. RH HB401 & 505 models.
	C11401	Footplate. LH HB401 & 505 models.
	C11403	Footplate. RH HB510.
	C11404	Footplate. LH HB510.
	C11407	Footplate. Right hand Classic HB505.
	C11408	Footplate. Left hand Classic HB505.
	C11412	Footplate. Right hand Classic HB510.
	C11413	Footplate. Left hand Classic HB510.

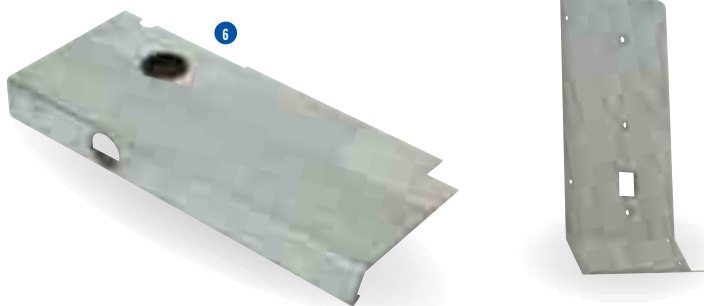









Model Specific

Large Horseboxes HB510XL & HB610



HB610 with KX4320 window guard kit fitted

HORSE PARTITION KITS

-  **KX0117 Full Width Partition Kit.** HB510XL Simply hang on the mounting rail & clip in place. Silver finish to the partition with a clear plastic skirt.
-  **1 KX0118 Full Width Partition Kit.** HB610 Simply hang on the mounting rail & clip in place. Silver finish to the partition with a clear plastic skirt.
-  **P10851 Head Partition Kit.** HB510XL & HB610 Bolts on to any existing full width partition.
-  **KX0107 Saloon Door Partition Kit.** One pair of short saloon type wooden partition doors to fit all versions of HB510XL complete with rubber skirts and securing belt.
-  **KX0109 Saloon Door Partition Kit.** One pair of short saloon type wooden partition doors to fit HB610 models complete with rubber skirts and securing belt.
-  **KX01092 Solid Saloon Door Partition Kit.** One pair of tall saloon type wooden partition doors (no rubber skirt) to fit all versions of HB510XL complete with securing belt.
-  **KX01301 Centre Partition Kit.** Traditional style "side by side" partition system for carrying two large horses facing forwards in the HB510XL. Supplied with silver padded centre partition panels, Black breast and breeching bars, centre pole and all fittings.
-  **KX01291 Centre Partition Kit.** Traditional style "side by side" partition system for carrying two large horses facing forwards in the HB610. Supplied with silver padded centre partition panels, Black breast and breeching bars, centre pole and all fittings.

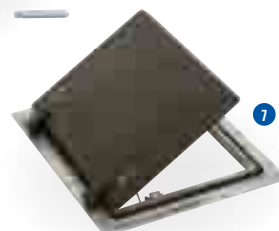

OPTIONAL ACCESSORIES

- KX4322 Window Guard Kit.** Black powder coated bars (4) & fasteners for HB510XL-10.
- KX4321 Window guard Kit.** Black powder coated bars (6) & fasteners for HB510XL.
- KX4320 Window Guard Kit.** Black powder coated bars (5) & fasteners for HB610.
- KX0240 Wheel Chocks.** Pair of wheel chocks & holders (fit on outside of trailer).
- 2 KX01168 Breeching Bar.** HB510XL fits across rear ramp aperture (Black).
- KS26858 Breast Bar.** HB610 fits across front ramp aperture (Black).
- KS27258 Breeching Bar.** HB610 fits across rear ramp aperture (Black).

DEDICATED SPARE PARTS

- C14697 Outer Roof Sheet.** Right hand HB610
- C14695 Outer Roof Sheet.** Left hand HB610 (Left & Right hand HB510XL)
- C14696 Centre Roof Sheet.** HB610
- C14689 Centre Roof Sheet.** HB510XL
- C19353 Roof Channel.** HB610
- C19345 Roof Channel.** HB510XL
- AS0767 Aluminium Floor.** Multi-planked Aluminium floor assembly to fit HB510XL-10.
- AS0770 Aluminium Floor.** Multi-planked Aluminium floor assembly to fit HB510XL.
- AS0725 Aluminium Floor.** Multi-planked Aluminium floor assembly to fit HB610.
- C80848 Rubber Matting.** One piece rubber matting to fit HB510XL (cut to fit HB510XL-10).
- C80849L Rubber Matting.** Left side Half matting to fit HB610.
- C80849R Rubber Matting.** Left side Half matting to fit HB610.
- KS3007 Rear Doors.** Pair of doors fitted above rear ramp on HB510XL 7' Headroom.
- KS3004 Rear Doors.** Pair of doors fitted above rear ramp on HB510XL 2.3M Headroom.
- KS3008 Rear Doors.** Pair of doors fitted above rear ramp on HB610 7' Headroom.
- KS3009 Rear Doors.** Pair of doors fitted above rear ramp on HB610 2.3M Headroom.
- C72053 GRP Nosecone.** Basic (non-storage) version for HB510XL models.
- C72049 GRP Nosecone.** Storage nose version for HB510XL models.
- C72056 GRP Nosecone.** Storage nose version for HB610 models.
- KS0920 Storage Nose Conversion Kit.** Full kit of parts to convert basic HB510XL models to the storage nose system. Includes GRP nosecone, upper front panel, sliding doors, track and all fasteners required.
- P1079 Spring Lock.** Large over-centre ramp fastener used on HB610 front & rear ramps.
- AS7792 Spring Lock Receiver.** Large tab type used on rear ramp of HB610.
- AS7793 Spring Lock Receiver.** Short tab type used on front ramp of HB610.
- 3 P11135 Tie Ring.** With plastic skirt as fitted to interior HB510XL & HB610.
- 4 P1066 Lockable Inspection Door Lock.**
- 5 P1079 Over Centre Ramp Catch.** Used on the front and rear ramps of the HB610.
- 6 C31249 Ramp Handle.** Used on the rear ramp of the HB510XL.
- 7 P1212 Sliding Window**
- 8 P1212/B Push Button.** For the sliding window

To order see pages 4&5 for distributor details or call 0845 4082 505. Prices available on separate Spares Pricelist

To order see pages 4&5 for distributor details or call 0845 4082 505. Prices available on separate Spares Pricelist



Increase the versatility of your 7' headroom livestock trailer by adding this optional horse partition kit. Versions are available to fit trailers with or without sheep decks. Also suitable for use on the Sealed floor models.

Please note:
Colour and style of the partition leaf and breaching bars may differ from this illustration

TA510 12' long 7' headroom with KX0186 horse partition kit fitted

KX0181	Horse Partition Kit TA5G 7'. No Decks 10' long Horsebox style centre partition kit, includes breast/breaching bars and receivers.*
KX0183	Horse Partition Kit TA5G 7'. No Decks 12' long Horsebox style centre partition kit, includes breast/breaching bars and receivers.*
KX0186	Horse Partition Kit TA510G. No Decks 10' long Horsebox style centre partition kit, includes breast/breaching bars and receivers.*
KX0187	Horse Partition Kit TA510G. No Decks 12' long Horsebox style centre partition kit, includes breast/breaching bars and receivers.*
KX0182	Horse Partition Fittings. Fittings for the kit only (if partition is to be used in two trailers).
KX0191	Breaching Bar. Aluminium tube breaching bar for TA5 7' headroom (trailer without decks).
KX0196	Breaching Bar. Aluminium tube breaching bar for TA510 7' headroom (trailer without decks).

KX0171	Full Width Breast/Breaching Bar. TA5 7' models without decks. (Horse partition fittings need to be installed).
KX0173	Full Width Breast/Breaching Bar. TA510 7' models without decks. (Horse partition fittings need to be installed).
AS7459	Fixing Bracket. Fixes the centre partition pole to the trailer roof. 12' Trailers.
AS7509	Fixing Bracket. Fixes the centre pole to the trailer roof. 10' Trailers.
C00077	Clevis Pin. Used to secure the centre partition pole to the upper bracket (HB505/510 or TA5 models with horse kit).
F1913Z	R Clip. Holds the centre partition clevis securely in place.
C31250	Receiver Bracket. Three hole breaching bar receiver bracket.
AS4373	Fixing Plate. Floor receiver for the centre pole, suitable for use on the sealed floor trailer.

* Distributor fit only. Fitting charges may apply.



RAMP SPARES

C497113	Ramp Plank. TA5G Easyload™ ramp 1365mm.
C497112	Ramp Plank. TA5G Cattle Ramp 1444mm.
C497132	Ramp Plank. TA510G Cattle ramp 1674mm.
C497135	Ramp Plank. TA510G Easyload™ 1595mm.
C497133	Ramp Plank. DP120G Cattle ramp 1690mm.
C49706	Ramp Plank. DP120G Easy load™ 1610mm.
1 C14324	Ramp Closure Handle. Right hand side.
C14325	Ramp Closure Handle. Left hand side.
2 C11968	Receiver. For ramp closure handles.
3 C01690	Ramp Closure Lock Pin.
P1288	Spring. Used with C01690 lock pin.
C04217	Ramp Spring Attachment Bracket. Right hand.
C04219	Ramp Spring Attachment Bracket. Left hand.
4 AS1744	Ramp Pivot. TA5G/TA510G Right hand.
AS1745	Ramp Pivot. TA5G/TA510G Left hand.
5 AS4330	Ramp Hinge Block. DP120G Right hand.
AS4331	Ramp Hinge Block. DP120G Left hand.
6 C20937	Ramp Hinge Tube. Used on the current DP120G models.
7 P1161	Ramp Spring. Used on all current livestock Trailers.
8 P1246	Hinge Pivot Bush.
9 P12361	M8 Pin and Knob Moulded.

REAR CORNER PILLARS

C14370	Right Hand Rear Corner Pillar TA5G/TA510G 6'.
C14371	Left Hand Rear Corner Pillar TA5G/TA510G 6'.
C14372	Right Hand Rear Corner Pillar TA5G/TA510G 7'.
C14373	Left Hand Rear Corner Pillar TA5G/TA510G 7'.
C14328	Right Hand Rear Corner Pillar DP120G.
C14329	Left Hand Rear Corner Pillar DP120G.



To order see pages 4&5 for distributor details or call 0845 4082 505. Prices available on separate Spares Pricelist

To order see pages 4&5 for distributor details or call 0845 4082 505. Prices available on separate Spares Pricelist

ROOF SHEETS

C14701	Roof Sheet. P8G - 2 per trailer.
C14705	Roof Sheet. TA5G 8' - 2 per trailer.
C14706	Roof Sheet. TA5G 10' - 2 per trailer.
C14707	Roof Sheet. TA5G 12' - 2 per trailer.
C14710	Roof Sheet. TA510G 10' - 2 per trailer.
C14711	Roof Sheet. TA510G 12' - 2 per trailer.
C14712	Roof Sheet. TA510G 14' - 2 per trailer.
C14715	Roof Sheet. DP120G 10' - 2 per trailer.
C14716	Roof Sheet. DP120G 12' - 2 per trailer.
C14717	Roof Sheet. DP120G 14' - 2 per trailer.
C14773	Centre Roof Sheet. 7' Headroom 10' long - 1 per trailer.
C14760	Centre Roof Sheet. 7' Headroom 12' long - 1 per trailer.
C14720	Centre Roof Sheet. 7' Headroom 14' long - 1 per trailer.

ROOF CHANNELS

C19322	Roof Channel. P8G 4' Headroom & P6G.
C19323	Roof Channel. P8G 5' Headroom.
C19324	Roof Channel. TA5G 4' Headroom.
C19314	Roof Channel. TA5G 6' Headroom.
C19306	Roof Channel. TA5G 7' Headroom.
C19309	Roof Channel. TA510G 6' Headroom.
C19302	Roof Channel. TA510G 7' Headroom.
C19307	Roof Channel. DP120G.

FRONT PANELS

C49125	Front Panel. P6G/P8G.
C49114	Front Panel. TA5G 4' Headroom.
C49070	Top Front Panel. TA5G 6' Headroom.
C49114	Top Front Panel. TA5G 7' Headroom.
C49060	Bottom Front Panel. TA5G.
C49071	Top Front Panel. TA510G 6' Headroom.
C49113	Top Front Panel. TA510G 7' Headroom.
C49061	Bottom Front Panel. TA510G.
C49072	Top Front Panel. DP120G.
C49062	Bottom Front Panel. DP120G.

SIDE PANELS

C44774	Side Panel. 6' (1879.5mm)
C44776	Side Panel. 8' (2495.5mm)
C44780	Side Panel. 10' (3111.5mm)
C44784	Side Panel. 12' (3727.5mm)
C44788	Side Panel. 14' (4343mm)

INSPECTION DOORS

KS2220	Inspection Door Set. Upper & lower TA5G & TA510G
KS2221	Inspection Door. Upper TA5G & TA510G
KS2222	Inspection Door. Lower TA5G & TA510G
KS2225	Inspection Door Set. Upper & Lower DP120G

DRAWBARS

AS0659	Drawbar kit. For the DP120S Sealed floor
AS7237	Drawbar Kit. For the DP120G (pre sealed floor)



VENTS, TIE POINTS & LIFTING HANDLES

1 C48990	Aluminium Vent. Used on all current livestock trailers except for 4' headroom models.
2 C89200	Rubber Hinge. Used as pivot for current vents
3 P1245PK	Deck Cleat. Fitted to the side panels of current livestock trailers to secure vents in the open position. Sold in packs of 10.
C75373	Shoot Bolt. Used on current vents to secure in the closed position.
C75374	Shoot Bolt Spring. Used on current vents to secure in the closed position.
C49119	Aluminium Vent. Used on the current 4' headroom TA5G & TA510G
4 P1226	Turn Button. Used with the current C49119 vents and on all standard livestock trailers pre 1997.
5 P1230	Vent Hinge. Used with the current C49119 vents and on all standard livestock trailers pre 1997.
6 AS0611	Tie Ring. Solid galvanized steel ring welded to a back plate.
AS0744	Tie Ring. Loose ring inserted into bolt fitting.
7 C05871	Lifting Handle. Fitted to the DP120 container body to facilitate removal.

BODY RAILS

Cross Division Receiver Rails

Galvanised steel slotted channel, waist height on left hand body side.

C12018	6' long for 8' body.
C12019	8' long for 10' body.
C12020	10' long for 12' body.
C12021	12' long for 14' body.

Cross Division Base Rails

Galvanised steel slotted rail just above floor on right hand body side.

C14165	8' long for 8' body.
C14166	10' long for 10' body.
C14167	12' long for 12' body.
C14168	14' long for 14' body.

Roof Rail - Left Hand

Galvanised steel section with oval holes, fitted in top left hand corner of body.

C14140	6' long for 8' body.
C14141	8' long for 10' body.
C14142	10' long for 12' body.
C14175	12' long for 14' body.

Roof Rail - Right Hand

Galvanised steel section with round holes, fitted in top right hand corner of body.

C14170	8' long for 8' body.
C14171	10' long for 10' body.
C14172	12' long for 12' body.
C14174	14' long for 14' body.

Roof/Vent Rails

Aluminium extrusion at the base of the roof sheet and forming the top edge of the roof vent.

C48899	6' long for P6 bodies.
C48900	8' long for P8 & TA5G 8'.
C48901	10' long for 10' body.
C48902	12' long for 12' body.
C48903	14' long for 14' body.

Panel Top & Vent Blocker Rails

Aluminium extrusion fitted to the top edge of both upper and lower side panels. Also used to block lower vents when vent flaps are not secured by shoot bolts.

C48920	6' long for 8' body Left Hand.
C48921	8' long for 10' body Left Hand and 8' body Right Hand.
C48922	10' long for 12' body Left Hand 10' body Right Hand.
C48923	12' long for 14' body Left Hand and 12' body Right Hand.
C48924	14' for 14' body Right Hand.

Panel Bottom Rails

Aluminium extrusion fitted to the lower edge of the upper side panels.

C48940	6' long for 8' body Left Hand.
C48941	8' long for 10' body Left Hand and 8' body Right Hand.
C48942	10' long for 12' body Left Hand 10' body Right Hand.
C48943	12' long for 14' body Left Hand and 12' body Right Hand.
C48944	14' for 14' body Right Hand.

Vent Gap Blocker Kits

This kit contains one left hand (short) and one right hand (long) rail plus fittings. These can be used to block upper vent gaps (where vent rails were never fitted) or lower vent gaps where the vents are held closed by shoot bolts but the user prefers the previously fitted blocker rails. Please note that's one kit will only block the upper or lower vents. Two kits would be required to block the upper and lower vents.

KX2100	Vent Gap Reducer Kit. For 8' Trailers.
KX2101	Vent Gap Reducer Kit. For 10' Trailers.
KX2102	Vent Gap Reducer Kit. For 12' Trailers.
KX2103	Vent Gap Reducer Kit. For 14' Trailers.

Please specify when ordering if the trailer has sheep decks fitted.

Front Panel Cross-Members

Galvanised steel cross-members fitted inside the front panels as described below:

C19338	P6G/P8G.
C19337	TA5G. Top and middle positions (2 per trailer).
C24203	TA5G. Lower position.
C19335	TA510G. Top and middle positions (2 per trailer).
C24204	TA510G. Lower position.
C19332	DP120G. Top and middle positions (2 per trailer).
C24205	DP120G. Lower position.

Lighting Plates - DP120

C12001	Lighting Plate. For trailers manufactured pre 2005.
C12035	Lighting Plate. For later sealed floor trailers manufactured from 2005 onwards, can be identified by having a square box section floor bearer about 30cm from the rear. This can be seen clearly when viewing from the outside of the Trailer.

Foot-Plates

Galvanised steel pressings fitted to the TA5G & TA510G immediately behind the wheels.

C14151	8' Right Hand.
C14152	8' Left Hand.
C14153	10' Right Hand.
C14154	10' Left Hand.
C14155	12' Right Hand. Twin axle.
C14156	12' Left Hand. Twin axle.
C14149	12' Right Hand. Tri-axle.
C14150	12' Left Hand. Tri-axle.
C14157	14' Right Hand. Twin axle.
C15158	14' Left Hand. Twin axle.
C14159	14' Right Hand. Tri-axle.
C14160	14' Left Hand. Tri-axle.



Model Specific

Livestock Cross Divisions - Small cross divisions from current Sealed floor models - Pre-98

Small cross divisions are for trailers with sheep decks deployed.

1	KX4750	TA5G 6' Upper. Sealed floor models - from Jan 2005 onwards.
	KX4750/7	TA5G 7' Upper. Sealed floor models - from Jan 2005 onwards.
	KX4751	TA5G Lower. Sealed floor models - from Jan 2005 onwards.
	KX4752	TA510G 6' Upper. Sealed floor models - from Jan 2005 onwards.
	KX4752/7	TA510G 7' Upper. Sealed floor models - from Jan 2005 onwards.
	KX4753	TA510G Lower. Sealed floor models - from Jan 2005 onwards.
	KX4754	DP120G Upper. Sealed floor models - from May 2005 onwards.
	KX4755	DP120G Lower. Sealed floor models - from May 2005 onwards.
2	KX4775	Lower TA5G from late 2004 - Jan 2005. Latching rails and heavy duty catch.
	KX4777	Lower TA510G from late 2004 - Jan 2005. Latching rails and heavy duty catch.
	KX4779	Lower DP120G from late 2004 - May 2005. Latching rails and heavy duty catch.
3	KX4785	Upper TA5G 6' from 2000 - Jan 2005.
	KX4785/7	Upper TA5G 7' from 2000 - Jan 2005.
	KX4786	Lower TA5G from 2000 - late 2004.
	KX4787	Upper TA510G 6' from 2000 - Jan 2005.
	KX4787/7	Upper TA510G 7' from 2000 - Jan 2005.
	KX4788	Lower TA510G from 2000 - late 2004.
	KX4789	Upper DP120G from 2000 - May 2005.
	KX4790	Lower DP120G from 2000 - late 2004.
4	KX4875	Upper TA5G 6' 1998/1999.
	KX4875/7	Upper TA5G 7' 1998/1999.
	KX48755	Lower TA5G 1998/1999.
	KX4876	Upper TA510G 6' 1998/1999.
	KX4876/7	Upper TA510G 7' 1998/1999.
	KX48765	Lower TA510G 1998/1999.
	KX4877	Upper DP120G 1998/1999.
	KX48775	Lower DP120G 1998/1999.

When transporting livestock, full use should be made of partitions to ensure that the animals are not thrown about by the motion of the vehicle. This is one of the provisions of the Transit of Animals Regulations, and it is most important for the safe towing of the trailer.



TA510 12' with optional ramp gate extensions

Model Specific

Livestock Cross Divisions - Large cross divisions from current sealed floor - Pre-98

Large cross divisions are used in trailers without decks when cattle are being carried.

KX4765	TA5G 6' Sealed floor models from Jan 2005 onwards.
KX4765/7	TA5G 7' Sealed floor models from Jan 2005 onwards.
KX4766	TA510G 6' Sealed floor models from Jan 2005 onwards.
KX4766/7	TA510G 7' Sealed floor models from Jan 2005 onwards.
KX4767	DP120G Sealed floor models from May 2005 onwards.
KX4770	TA5G 6' From late 2004 – Jan 2005.
KX4770/7	TA5G 7' From late 2004 – Jan 2005.
KX4771	TA510G 6' From late 2004 – Jan 2005.
KX4771/7	TA510G 7' From late 2004 – Jan 2005.
KX4772	DP120G 6' From late 2004 – May 2005.
KX4780	TA5G 6' from 2000 – 2004.
KX4780/7	TA5G 7' from 2004 – 2004.
KX4781	TA510G 6' from 2000 – 2004.
KX4781/7	TA510G 7' from 2000 – 2004.
KX4782	DP120G 6' from 2000 – 2004.
KX4880	TA5G 6' from 1998 – 2000.
KX4880/7	TA5G 7' from 1998 – 2000.
KX4881	TA510G 6' from 1998 – 2000.
KX4881/7	TA510G 7' from 1998 – 2000.
KX4882	DP120G 6' from 1998 – 2000.
KX4852/6	TA5G 6' Suitable for galvanized trailers pre 1998.
KX4852/7	TA5G 7' Suitable for galvanized trailers pre 1998.
KX4853/6	TA510G 6' Suitable for galvanized trailers pre 1998.
KX4853/7	TA510G 7' Suitable for galvanized trailers pre 1998.
KX4854/6	DP120G 6' Suitable for galvanized trailers pre 1998.

When transporting livestock, full use should be made of partitions to ensure that the animals are not thrown about by the motion of the vehicle. This is one of the provisions of the Transit of Animals Regulations, and it is most important for the safe towing of the trailer.



DP120 10' with KX4782 large cross division fitted



To order see pages 4&5 for distributor details or call 0845 4082 505. Prices available on separate Spares Pricelist

SINGLE HEIGHT LIVESTOCK MODELS

KX4846	Cross Division (Timber). P6e - To partition the trailer when carrying certain livestock (fits livestock variant only).
KX4874	Cross Division. P6/8G.
KX4874/5	Cross Division. P6/8 (5' headroom) - Standard cross division.
KX4870	Cross Division. TA5 (4' headroom) Standard cross division.
KX4760	Cross Division. To suit later type TA5G 4' headroom (models with tapered rear pillars).

When transporting livestock, full use should be made of partitions to ensure that the animals are not thrown about by the motion of the vehicle. This is one of the provisions of the Transit of Animals Regulations, and it is most important for the safe towing of the trailer.



TA5 10' (4' headroom)



P6G livestock trailer fitted with KX4874 cross division

To order see pages 4&5 for distributor details or call 0845 4082 505. Prices available on separate Spares Pricelist

Model Specific

Livestock Cross Division Parts

- 1 C00600 **Swivel Handle. Part of the Spring Bolt.** Used on cross divisions from 2000 - 2004.
- P1236 **Knob 8mm. Used with C00600.** Used on cross divisions from 2000 - 2004.
- 2 AS4779 **Catch.** Used on cross divisions from 2000 - 2004.
- C11975 **Anti Lift Bracket.** Used alongside the catch on cross divisions from 2000 - 2004.
- 3 AS5870 **Spring Bolt.** Used on all large cross divisions from 1998.
- 4 C05273 **Spring Bolt Receiver.** Fixed to the roof of the trailer.
- 5 C05274 **Spring Bolt Receiver. Double Receiver.** Fixed to the roof of the trailer.
- 6 C15227 **Receiver Channel.** For spring bolts of large cross divisions.
- 7 C74419 **Pivot Bush.** Bolted to the livestock deck, this nylon bush acts as a pivot for the upper cross divisions.
- 8 P1171 **Spring.** For the spring bolts. Used on cross divisions up to 2004.
- 9 P1179 **Spring.** For the spring bolts. Used on cross divisions up to 2000.
- 10 P12871 **Return Spring.** Used on cross divisions from 2004.
- 11 KS4183 **Cross Division Pivot Bracket Assembly. TA5G/TA510G** Jan 2005 onwards.
- KS4184 **Cross Division Pivot Bracket Assembly. DP120** Jan 2005 onwards
- 12 C11973 **Locating Bracket. Latch side, lower.** Fitted to the outside of the trailer to hold a stowed cross division. Used till end of 2005.
- 13 C11974 **Locating Bracket. Latch Side, Centre.** Fitted to the outside of the trailer to hold a stowed cross division. Used till end of 2005
- 14 C14208 **Locating Bracket. Hinge side, centre.** Fitted to the outside of the trailer to hold a stowed cross division. Used till end of 2005.
- 15 C12005 **Cross Division Storage Base.** Fitted to the front outside panel to hold a stowed cross division. Used since early 2006.
- C02005 **Cross Division Storage Base Retaining Pin.**
- P1110/LS **Cross Division Storage Linch Pin.**

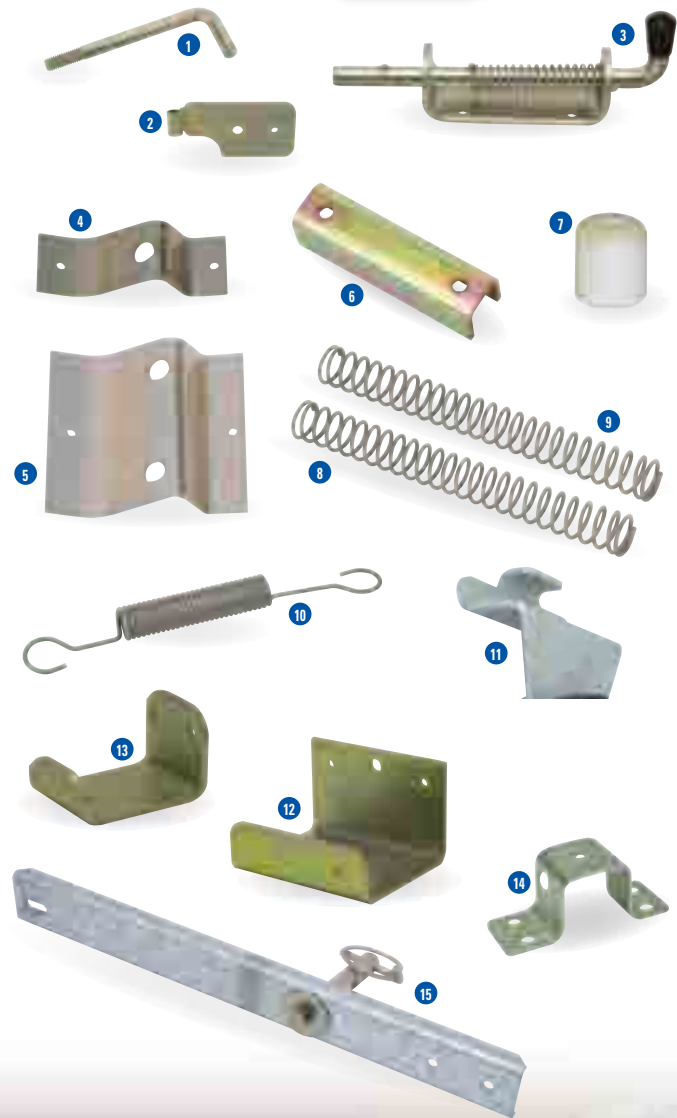

To order see pages 4&5 for distributor details or call 0845 4082 505. Prices available on separate Spares Pricelist



TA510 12' with optional ramp gate extensions

DECK COMPONENTS

- 1 AS4192 **Deck Retainer.** Holds the decks in the raised position.
- 2 C14542 **Receiver Bracket.** Fitted to the deck side rail to locate the deck braces.
- 3 P1074 **Butt Hinge.** Used to hinge the front deck to the front panel.
- 4 P1075 **Double Knuckle Hinge.** Used to hinge inner and outer sections of the folding side decks together.
- 5 C44934 **Outer Deck Hinge Leaf.** Used to hinge the outer side deck to the side of the trailer. Requires F0334Z bolts for the 2 leaf hinge & F0332Z bolts for the 3 leaf hinge & F1051 nuts.
- C12240 **Deck Brace.** TA5G
- C12241 **Deck Brace.** TA510G
- C12242 **Deck Brace.** DP120G
- 6 AS1963 **Deck Brace Slider Assembly.** Must be fitted to the front deck brace to prevent front deck instability and also used when deck bars are locating small lower cross divisions without the decks being deployed (small cross divisions used as pens). Two required per deck bar.
- 7 AS1868 **Side Arm Assembly Right hand.** Compatible with AS1860,61, 62 & AS1960, 61 & 62 rear barriers.
- 8 AS1869 **Side Arm Assembly Left hand.** Compatible with AS1860,61,62 & AS1960, 61 & 62 rear barriers.
- 9 KS3210 **Rear Barrier Retrofit Kit.** Enables the conversion of AS1960,61 & 62 rear barriers to the latest system. Compatible with TA5G, TA510G & DP models.

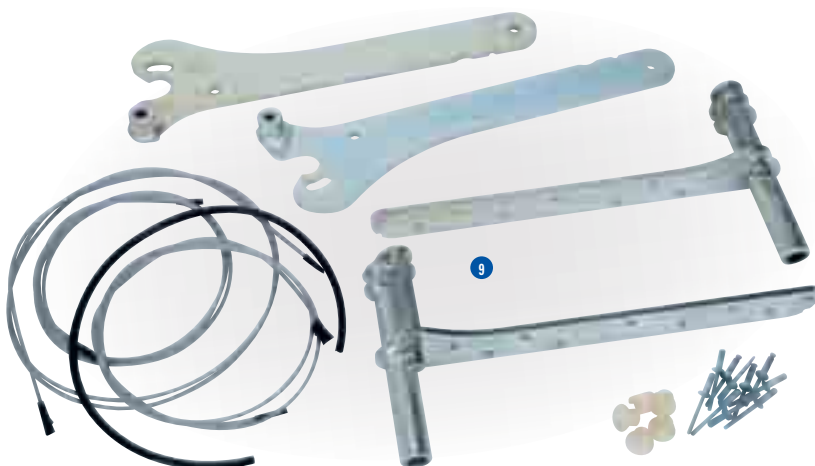
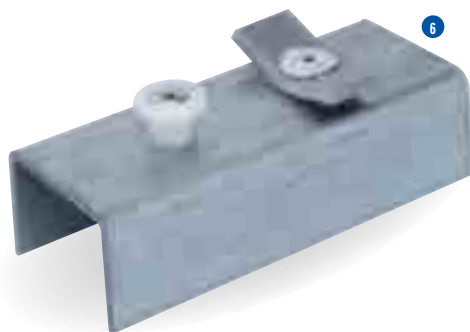
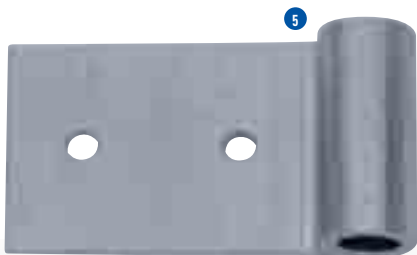
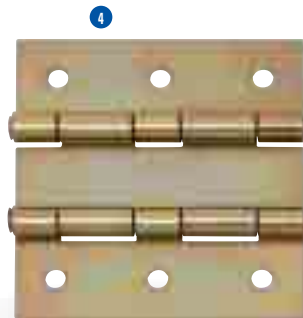

To order see pages 4&5 for distributor details or call 0845 4082 505. Prices available on separate Spares Pricelist

Model Specific

Livestock - Guide to Rear Deck Barriers



DP120 12' with Easy load sheep deck and cross division

To order see pages 4&5 for distributor details or call 0845 4082 505. Prices available on separate Spares Pricelist

1 Model	Fixed deck system (up to Feb 2007)	Tilting deck system (Feb 2007 – early 2010)	Easy lift Tilting deck system (Early 2010 – present)
TA5G	AS1860	AS1960	AS1960-NB
TA510G	AS1861	AS1961	AS1961-NB
DP	AS1862	AS1962	AS1962-NB

C44190	Drop Leaf Rear Deck. TA5G used with the tilting deck system (Feb 2007 onwards) Final removable deck section.		
2 C44191	Drop Leaf Rear Deck. TA510G used with the tilting deck system (Feb 2007 onwards) Final removable deck section		
C44192	Drop Leaf Rear Deck. DP used with the tilting deck system (Feb 2007 onwards) Final removable deck section		



To order see pages 4&5 for distributor details or call 0845 4082 505. Prices available on separate Spares Pricelist

	KS0046	Ramp Gates (pair). P6/8 Aluminium rampgates.
	C14737	Rampgate Bracket. P6e RH upper rampgate support bracket fits inside canopy.
1	C14738	Rampgate Bracket. P6e LH upper rampgate support bracket fits inside canopy.
	KS2991	Ramp Gates (pair). TA5 current production version.
	KS29911	Ramp Gate RH. TA5 current production version.
	KS29912	Ramp Gate LH. TA5 current production version.
	KS2993	Ramp Gates (pair). TA510 current production version.
	KS29931	Ramp Gate RH. TA510 current production version.
	KS29932	Ramp Gate LH. TA510 current production version.
	KS2995	Ramp Gates (pair). DP120 current production version.
	KS29951	Ramp Gate RH. DP120 current production version.
	KS29952	Ramp Gate LH. DP120 current production version.
2	C49930	Ramp Gate Pivot. Used on current TA5G, TA510G & DP120G models.
	C24221	Ramp Gate Retaining Pin. Used on current TA5G, TA510G & DP120G models.
	C04207	Rampgate Pin. Used to secure the lower (pivot) leg of the rampgate in the trailer floor.
	C14732	Rampgate Catch. Allows one rampgate to hold the other closed.
	KS0044	Ramp Gates (pair). TA5G. For trailers manufactured before 1998.
	KS0045	Ramp Gates (pair). TA510G & DP120G. For trailers manufactured before 1998.
	KS0071	Ramp Gates (pair). Horsebox container rampgate kit (rear ramp).
3	KX4890	Ramp Gate Extension. TA5/510 rampgate extension (2' wide) allows the ramp gate to be extended for better stock control.
4	KX4891	Ramp Gate Extension. DP120 rampgate extension (4' wide) allows the ramp gate to be extended for better stock control.
5	C24220	Retaining Pin. For Rampgate extensions on TA5, 510 & DP120 models. Also secures P6 & P8 ramp gates.
6	C14209	Locating Bracket. Rampgate extension bracket, also used on some earlier cross division front panel mountings.
7	C75363	Capping Insert. fits into end of ramp gate vertical member to hold hinge or retainer pieces.
	AS3040	Wooden Back Rail. Fits the P6E & P7E.
	KS2970	Aluminium Back Rail. Fits above the rear ramp on the TA5G 6' low ramp model.
	KS2971	Aluminium Back Rail. Fits above the rear ramp on the TA5G 7' low ramp model.
	KS2972	Aluminium Back Rail. Fits above the rear ramp on the TA5G 7' deck model.
	KS2974	Aluminium Back Rail. Fits above the rear ramp on the TA510G 6' low ramp model.
	KS2975	Aluminium Back Rail. Fits above the rear ramp on the TA510G 7' low ramp model.



TA5 12' with ramp gate extensions in use.













Model Specific

Livestock - DP120S Accessories, Sump Tanks & GRP Wind Deflectors



DP120 14' Tri-axle with decks and KX4920 Sump tank fitted

SUMP TANK KITS ETC.

-  **1 KX4900 Sump Tank Kit TA5.** Includes tank with screw-off lids, a pair of floor drain points, rear dam & all fasteners required to install (This kit is dealer fit only).*
-  **KX4910 Sump Tank Kit TA510.** Includes tank with screw-off lids, a pair of floor drain points, rear dam & all fasteners required to install (This kit is dealer fit only).*
-  **KX4920 Sump Tank Kit DP120S.** Includes tank with screw-off lids, a pair of floor drain points, rear dam & all fasteners required to install (This kit is dealer fit only).*
-  **2 KS4925 Sump Drain Cap.** Black screw-off cap complete with seal & fixing chain.
- C12032 Skid & Tank Support.** R/H DP120S.
- C12033 Skid & Tank Support.** L/H DP120S.
-  **KX0245 Skid Carrier & Propstands.** For DP120 "Sealed floor" carrier, legs and brackets (Loading skids not included - Trailers from Serial Number 451329 onwards).
-  **KX1130 Headboard.** To fit the DP120 sealed floor.
-  **KX1140 Headboard.** DP120S 2010+.
-  **3 KX4949 Chassis Mounted Spare Wheel Bracket.** For the DP120S. Can allow for greater manoeuvrability between vehicle and trailer than the standard drawbar fitted bracket.
- C12223 Spare Wheel Bracket.** Drawbar mounted DP120S.
-  **4 KX2160 GRP Front Installation Kit.** TA5G 6' & TA5G 7', the kit includes all brackets & fasteners.
-  **KX2162 GRP Front Installation Kit.** TA510G 6', the kit includes all brackets & fasteners.
-  **KX2163 GRP Front Installation Kit.** TA510G 7', the kit includes all brackets & fasteners.
-  **KX2164 GRP Front Installation Kit.** DP120, the kit includes all brackets & fasteners.

* Distributor fit only. Fitting charges may apply.



KX4950 Container Removal Kit. Includes four adjustable legs, fittings and adjustment tool and guide to removing and re-fitting your DP120 container. If you have a Tri Axle trailer and are interested in this item, please contact our technical department for advice prior to purchase.



To order see pages 4&5 for distributor details or call 0845 4082 505. Prices available on separate Spares Pricelist



LM146 with KX1060 dropside kit fitted

DROPSIDE KITS *

KX1000	Dropside Kit. LT/LM85 including headboard.
KX1001	Dropside Kit. LT/LM85 Contains dropsides & tailboard (no headboard).
KX1010	Dropside Kit. LT/LM105 including headboard.
KX1011	Dropside Kit. LT/LM105 Contains dropsides & tailboard (no headboard).
KX1020	Dropside Kit. LT/LM125 including headboard.
KX1021	Dropside Kit. LT/LM125 Contains dropsides & tailboard (no headboard).
KX1040	Dropside Kit. LT/LM106 including headboard.
KX1041	Dropside Kit. LM/LT106G Dropsides, tailboard (no headboard).
KX1050	Dropside Kit. LT/LM126 including headboard.
KX1051	Dropside Kit. LT/LM126 Contains dropsides & tailboard (no headboard).
KX1055	Dropside Kit LM/LT126. For a trailer with ramp fitted.
KX1060	Dropside Kit. LT/LM146 including headboard.
KX1061	Dropside Kit. LT/LM146 Contains dropsides & tailboard (no headboard).
KX1060/76	Dropside Kit. LT/LM147 (2.3m wide) including headboard.
KX1070	Dropside Kit. LT/LM166 including headboard.
KX1072	Dropside Kit. CT166 contains dropsides & headboard.
KX1071	Dropside Kit. LT/LM166 Contains dropsides & tailboard (no headboard).
KX1070/76	Dropside Kit. LT/LM167 including headboard.
KX1073	Dropside Kit. CT167 including headboard.
KX1081	Dropside Kit. LM186 including headboard.
KX1081/76	Dropside Kit. LM187G including headboard.

* Dropside kits include centre pillars, rear pillars, tailboard and fixing kit. Available with or without headboard.





DROPSIDE KITS *

AS2270	Dropside. LT/LM 85 - Right hand dropside panel.
AS2271	Dropside. LT/LM 85 - Left hand dropside panel.
AS2250	Dropside. LT/LM 10' - Right hand dropside panel (5' panel).
AS2251	Dropside. LT/LM 10' - Left hand dropside panel (5' panel).
AS2255	Dropside. LT/LM 12' - Right hand dropside panel (6' panel).
AS2256	Dropside. LT/LM 12' - Left hand dropside panel (6' panel).
AS2260	Dropside. LT/LM 14' - Right hand dropside panel (7' panel).
AS2261	Dropside. LT/LM 14' - Left hand dropside panel (7' panel).
AS2265	Dropside. LT/LM 16' - Right hand dropside panel (8' panel).
AS2266	Dropside. LT/LM 16' - Left hand dropside panel (8' panel).
AS5190	Support Hinge. LT/LM Part of RH dropside panel - this is the right hand hinge on this panel.
AS5191	Support Hinge. LT/LM Part of RH dropside panel - this is the left hand hinge on this panel.
AS5195	Support Hinge. LT/LM Part of RH dropside panel - this is the centre pillar on this panel.
AS5192	Support Hinge. LT/LM Part of LH dropside panel - this is the right hand hinge on this panel.
AS5193	Support Hinge. LT/LM Part of LH dropside panel - this is the left hand pillar on this panel.
AS5194	Support Hinge. LT/LM Part of LH dropside panel - this is the centre hinge on this panel.
KS5262	Centre Pillar. Complete with lynch pins LT/LM/TT/CT.
KS5263	Rear Pillar. Right hand, complete with lynch pins LT/LM/CT.
KS5264	Rear Pillar. Left hand, complete with lynch pins LT/LM/CT.

Model Specific - Commercial

Drawbars and Suspension Cross Members

DRAWBARS

	AS7246 Drawbar Set. LT/LM85 – complete Left and Right hand drawbar assemblies.
	AS7232 Drawbar Set. LT/LM 5 series – complete Left and Right hand drawbar assemblies.
	AS7237 Drawbar Set. LT/LM 6 series – complete Left and Right hand drawbar assemblies.
	AS7230 Drawbar Set. LT/LM 7 series – complete Left and Right hand drawbar assemblies.
	AS7251 Drawbar Assembly. CT166G/ CT167G – Complete tilting drawbar assembly.

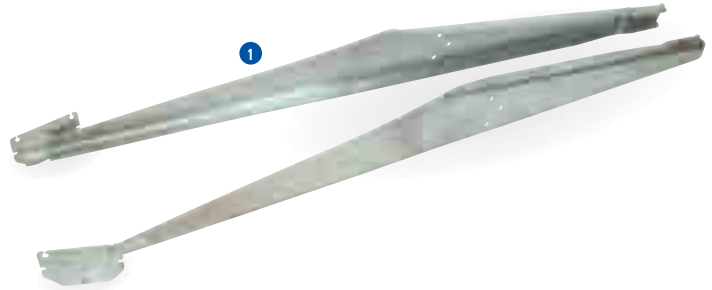

SUSPENSION CROSS MEMBERS

AS0940A	Suspension Cross Member. Front LT/LM 85G
AS0940B	Suspension Cross Member. Middle/rear LT/LM85G
AS0935A	Suspension Cross Member. Front LT/LM105G/125G
AS0935B	Suspension Cross Member. Middle LT/LM105G/125G
AS0935C	Suspension Cross Member. Rear LT/LM105G/125G
AS0930A	Suspension Cross Member. Front LM 6
AS0930B	Suspension Cross Member. Middle LM 6
AS0930C	Suspension Cross Member. Rear LM 6 (middle & rear on LM6 Tri-axle models)
AS0945A	Suspension Cross Member. Front LM 7
AS0945B	Suspension Cross Member. Middle LM 7
AS0945C	Suspension Cross Member. Rear LM 7 (middle & rear on LM 7 Tri-axle models)



To order see pages 4&5 for distributor details or call 0845 4082505. Prices available on separate Spares Pricelist



To order see pages 4&5 for distributor details or call 0845 4082 505. Prices available on separate Spares Pricelist



LT85 with KX1000 dropside kit and AS8416 ladder rack fitted

FOR THE LT/LM SERIES TRAILERS

- | | | |
|---|-----------|---|
| 1 | KX1100 | Headboard. LT/LM 85 complete headboard. |
| | KX1110 | Headboard. LT/LM 5 Series complete headboard (Not LT/LM 85). |
| | KX1120 | Headboard. LT/LM 6 Series complete headboard. |
| | KX1120/76 | Headboard. LT/LM 7 Series complete headboard. |
| | KX6197 | Sliding Winch Cover. Sliding cover kit for the middle section of the headboard to allow access for the winch cable. |
| 2 | AS2160 | Tailboard. LT/LM85 Complete tailboard assembly. |
| | AS2151 | Tailboard. LT/LM5 Series Complete tailboard assembly (Not LT/LM85). |
| | AS2155 | Tailboard. LT/LM6 Series Complete tailboard assembly. |
| | AS2156 | Tailboard. LT/LM7 Series Complete tailboard assembly. |
| | KS0328 | Tailboard. Beavertail 6'6". |
| | KS0329 | Tailboard. Beavertail 7'6". |
| 3 | KX1461 | Tailboard. Standard CT166G. |
| | KX8416 | Ladder Rack. LT/LM 85 - Open framed design. |
| | KX8409 | Ladder Rack. LT/LM 5 Series - Open framed design (Not LT/LM 85). |
| | KX8408 | Ladder Rack. LT/LM 6 Series - Open framed design. |
| | KX8449 | Ladder Rack. LT/LM 7 Series - Open framed design. |
| | KX5378 | Harvest Ladder. Fits most LT/LM 6 series trailers (Rear sockets have triangles on). |
| | AS5378 | Harvest Ladder Sockets. Allows the fitting of our harvest ladder to LT/LM 6 series trailers. |

Please note: LT/LM ladder rack can only be fitted to a trailer with a headboard.

Model Specific - Commercial

Ramps, Ramp Spares, Floor Capping, Lighting Plates & CT166, CT167 Spares



LM146 with dropside & meshside kit, winch and KX1420 high ramp and optional propstands fitted

FOR LT/LM & CT166 MODELS



KX1440	High Ramp. LT/LM 85 series includes hinges and all fittings to convert a trailer which has a tailboard.
KX1430	High Ramp. LT/LM 5 series includes hinges and all fittings to convert a trailer which has a tailboard (Not LT/LM85).
KX1420	High Ramp. LT/LM 6 series Includes hinges and all fittings to convert a trailer which has a tailboard.
KX1425	High Ramp. LT/LM 6 beavertail Includes hinges and all fittings to convert a trailer which has a tailboard.
KX1420/76	High Ramp. LT/LM 7 series Includes hinges and all fittings to convert a trailer which has a tailboard.
KX1460	High Ramp. CT166 Approx. 1 metre high to convert the standard short tailboard/ramp.
P1189	Gas Spring. CT166/167 models fitted with 1 metre high ramp.
C17264	Gas Strut Mounting Bracket. Lower. CT166/167 Ramp.
KS5280	Rear Ramp Pillar. Right hand LT/LM, complete with Linch Pins.
KS5281	Rear Ramp Pillar. Left hand LT/LM, complete with Linch Pins.
KS5285	Rear Ramp Pillar. Right hand Beavertail, complete with Linch Pins.
KS5286	Rear Ramp Pillar. Left hand Beavertail, complete with Linch Pins.

Adding a high ramp to the LT/LM Trailer range, will really save you time when loading and unloading wheeled equipment such as mowers.

FLOOR CAPPING & LIGHTING PLATES

C15004	Rear Floor Capping. LT/LM 85, protects the rear edge of the ply floor panel.
C15002	Rear Floor Capping. LM 5, protects the rear edge of the ply floor panel.
C15001	Rear Floor Capping. LM6, protects the rear edge of the ply floor panel.
C14996	Rear Floor Capping. LM7, protects the rear edge of the ply floor panel.
C10199	Lighting Plate. Pre punched and formed rear light plate LT/LM85G.
C10200	Lighting Plate. Pre punched and formed rear light plate LT/LM 5 Range.
C10201	Lighting Plate. Pre punched and formed rear light plate LT/LM 6 Range.
C10203	Lighting Plate. Pre punched and formed rear light plate LM 7 Range.

CT166/167 SPARES

1 AS7261	Rear Support Bracket. Bolted to the back of the CT166/167 to protect the chassis when body is tilted.
2 P1011	Body Clamp. Fitted to the drawbar to secure body of CT166/167.
3 P1011P	Body Clamp Receiver Plate.
4 P11415	Manual Pump.
P11415H	Manual Pump Handle.
5 P1139	Hydraulic Ram. 2 required per trailer.



To order see pages 4&5 for distributor details or call 0845 4082 505. Prices available on separate Spares Pricelist

To order see pages 4&5 for distributor details or call 0845 4082 505. Prices available on separate Spares Pricelist



LM146 with KX8568 meshside kit (trailer already has a ramp, winch and dropsides kit fitted)

MESH SIDE KITS

KX8553	Mesh Side Kit. LT/LM 85 trailers fitted with a tailboard.
KX8567	Mesh Side Kit. LT/LM 85 trailers fitted with a ramp.
KX8554	Mesh Side Kit. LT/LM105 trailers fitted with a tailboard.
KX8572	Mesh Side Kit. LT/LM105 trailers fitted with a ramp.
KX8559	Mesh Side Kit. LT/LM106 trailers fitted with a tailboard.
KX8573	Mesh Side Kit. LT/LM106 trailers fitted with a ramp.
KX8590	Mesh Side Kit. LT/LM125 trailers fitted with a tailboard.
KX8592	Mesh Side Kit. LT/LM125 trailers fitted with a ramp.
KX8591	Mesh Side Kit. LT/LM126 trailers fitted with a tailboard.
KX8593	Mesh Side Kit. LT/LM126 trailers fitted with a ramp.
KX8562	Mesh Side Kit. LT/LM146 trailers fitted with a tailboard.
KX8568	Mesh Side Kit. LT/LM146 trailers fitted with a ramp.
KX8662	Mesh Side Kit. LT/LM147 trailers fitted with a tailboard.
KX8668	Mesh Side Kit. LT/LM147 trailers fitted with a ramp.
KX8563	Mesh Side Kit. LT/LM166/CT166 trailers fitted with a tailboard.
KX8569	Mesh Side Kit. LT/LM166/CT166 trailers fitted with a ramp.
KX8672	Mesh Side Kit. LT/LM167/CT167 trailers fitted with a tailboard.
KX8678	Mesh Side Kit. LT/LM167/CT167 trailers fitted with a ramp.
KX8577	Mesh Side Kit. LM186 trailers fitted with a tailboard.
KX8578	Mesh Side Kit. LM186 trailers fitted with a ramp.
KX8682	Mesh Side Kit. LT/LM187 trailers fitted with a tailboard.
KX8688	Mesh Side Kit. LT/LM187 trailers fitted with a ramp.

MESH SIDE COMPONENTS

AS8427	Mesh Side Panel. LT/LM85 8' individual mesh side panel.
AS0191	Mesh Side Panel. LT/LM/TT 10' individual mesh side panel.
AS0221	Mesh Side Panel. LT/LM 12' individual mesh side panel.
AS8448	Mesh Side Panel. LT/LM 14' individual mesh side panel.
AS8441	Mesh Side Panel. LT/LM 16' right hand individual mesh side panel.
KX8596	Tie Bar Brace. For mesh sides on LM/LT1*6.
KX8597	Tie Bar Brace. For mesh sides on LM/LT1*5.
AS8412	Ladder Rack. LT/LM 5 series - incorporating mesh panel, for use with mesh sides (Not LT/LM 85).
AS8417	Ladder Rack. LT/LM 6 series - incorporating mesh panel, for use with mesh sides.
AS8429	Ladder Rack. LT/LM85 - incorporating mesh panel, for use with mesh sides.
AS8424	Mesh Rear Panel. LT/LM 5 series, used with mesh sides, the rear panel fits over the tailboard (Not LT/LM85).
AS8426	Mesh Rear Panel. 6 series, used with mesh sides, the rear panel fits over the tailboard.
AS8428	Mesh Rear Panel. LT/LM85, used with mesh sides, the rear panel fits over the tailboard.
KS5267	Rear Pillar for Mesh Sides. Right hand complete with linch pins. LT/LM/CT.
KS5268	Rear Pillar for Mesh Sides. Left hand complete with linch pins. LT/LM/CT.
KS5266	Centre Pillar for Mesh Sides. Complete with linch pins. LT/LM/CT.

DROPSIDES, HEADBOARDS & TAILBOARDS

AS2175 Tailboard. TT85G (post May 2000).

AS2176 Tailboard. TT105G.

KS0332 Tailboard. TT126G.

AS2216 Headboard. TT85G Incorporates ladder rack.

KX1110 Headboard. TT105G.

KX1120 Headboard. TT126G.

AS2270 Dropside. Right hand side TT85G.

AS2271 Dropside. Left hand side TT85G.

AS2250 Dropside. Right hand side TT105G.

AS2251 Dropside. Left hand side TT105G.

AS2255 Dropside. Right hand side TT126G.

AS2256 Dropside. Left hand side TT126G.

1 KS5041 Rear Pillar. Right hand side for TT126G, TT105G & TT85G (post May 2000) Complete with locking handle and linch pin.

KS5042 Rear Pillar. Left hand side for TT126G, TT105G & TT85G (post May 2000) Complete with locking handle and linch pin.



DEDICATED SPARE PARTS & ACCESSORIES

2 P1096 Linch Pin. Used to secure the tailboard.

3 C00178 Tailboard Locking Handle. Used on standard and mesh rear pillars to secure the tailboard.

P1194 End Cap. Fitted to the end of C00178 locking handle.

KS3990 Mudflap Kit. One pair includes hinges and fittings.

C10163 Pump Mounting Platform. Compatible with the Fluidlink pump.

C20125 Body Prop. Used on the TT85G, TT105G & TT126G.

4 KX0227 Propstand Kit. A pair of propstands, complete with bolt on spigots and full fixing kit.

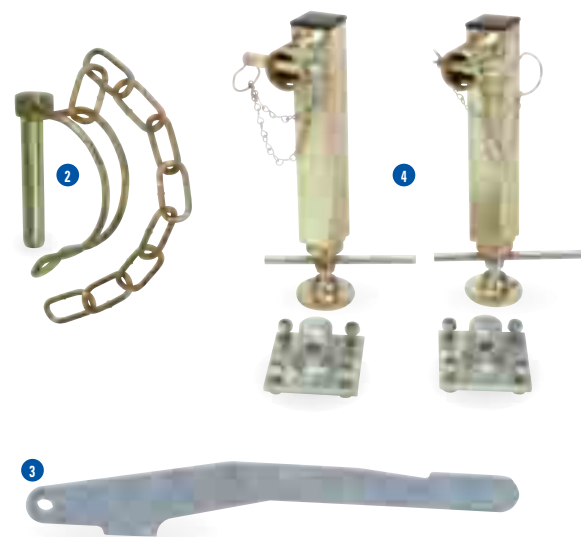

DRAWBARS & SUSPENSION CROSS MEMBERS

AS7235 Drawbar Set. TT105G. Left and Right hand side.

AS7205 Drawbar Set. TT126G. Left and Right hand side.

AS0935B Suspension Cross Member. TT105G Front.

AS0935C Suspension Cross Member. TT105G Middle & Rear.

AS0930C Suspension Cross Member. TT126G (4 used per trailer).



TT85 with electric hydraulic pump

LOADING SKIDS

KX5566 Loading Skids. A pair of 1.8m (6') formed steel loading skids. Suitable for the TT105G & TT126G. Suitable for trailers manufactured after May 1996 with side by side stowage.

KX5568 Loading Skids. A pair of 2.5m (8') formed steel loading skids. Suitable for the TT105G & TT126G. Suitable for trailers manufactured after May 1996 with side by side stowage.

KX5596 Loading Skids. A pair of 1.8m (6') lightweight aluminium loading skids. Suitable for the TT105G & TT126G. Suitable for trailers manufactured after May 1996 with side by side stowage.

KX5598 Loading Skids. A pair of 2.5m (8') Lightweight aluminium loading skids. Suitable for the TT105G & TT126G. Suitable for trailers manufactured after May 1996 with side by side stowage.



TT105 with optional propstands and KX8581 mesh side kit fitted



MESH SIDE KITS

- KX8570** **Mesh Side Kit.** TT85 Mesh side kit including mesh ladder rack, rear panel and all fittings. For trailers fitted with a tailboard.
- KX8581** **Mesh Side Kit.** TT105 Split mesh side kit including mesh ladder rack, rear panel and all fittings. For trailers fitted with a tailboard.
- KX8586** **Mesh Side Kit.** TT126 Split mesh side kit including mesh ladder rack, rear panel and all fittings. For trailers fitted with a tailboard.

MESH SIDE COMPONENTS

- AS9782** **Mesh Side Panel.** TT85 Individual mesh side panel.
- AS9780** **Mesh Front Panel.** For use with mesh sides, fits over the fixed ladder rack on the TT85 models.
- AS9781** **Mesh Rear Panel.** TT85G, Used with mesh sides, the rear panel fits over the tailboard.
- AS0187** **Mesh Rear Panel.** TT105, Used with mesh sides, the rear panel fits over the tailboard.
- AS0700** **Mesh Rear Panel.** TT126, Used with mesh sides, the rear panel fits over the tailboard.
- KS5045** **Rear Mesh Pillar.** Right hand side for TT85G (post May 2000) Includes locking handle and linch pin.
- KS5046** **Rear Mesh Pillar.** Left hand side for TT85G (post May 2000) Includes locking handle and linch pin.
- KS5043** **Rear Mesh Pillar.** Right hand side for TT105G & TT126G Includes locking handle and linch pin.
- KS5044** **Rear Mesh Pillar.** Left hand side for TT105G & TT126G Includes locking handle and linch pin.
- KS5266** **Centre Mesh Pillar.** For TT105G & TT126G Includes linch pins.

Model Specific - Commercial Tipper Range, Electrical, Heavy Duty Battery Components

- 1 P0655 Battery. 102 Ah heavy duty battery.
- 2 C15507 Battery Clamp Plate. Secures the battery on the current Tipper range.
- 3 P0656 Terminal Nuts. For our heavy duty battery P0655 (one each Red/Black).
- 4 P0670 Isolator Switch. Supplied with one removable key.
- 5 P0670A Isolator Key. Spare key for switch above.
- 6 P0733 Battery Cable (red). 16mm² flexible heavy duty cable (per metre).
- 7 P0734 Battery Cable (black). 16mm² flexible heavy duty cable (per metre).
- 8 P1127 Connector. 2 pole electrical connector for winch or tipper applications (2 required for plug/socket connection).
- 9 P0728 Crimp Terminal. For 16mm² cables.

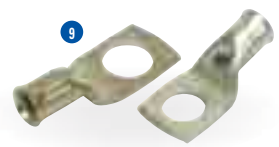
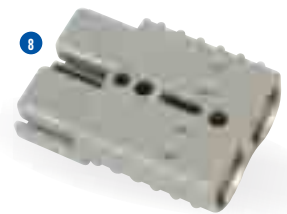
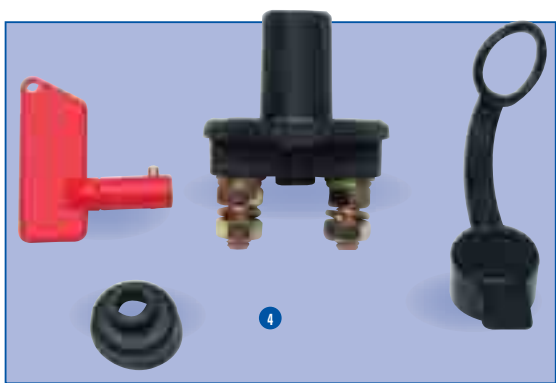
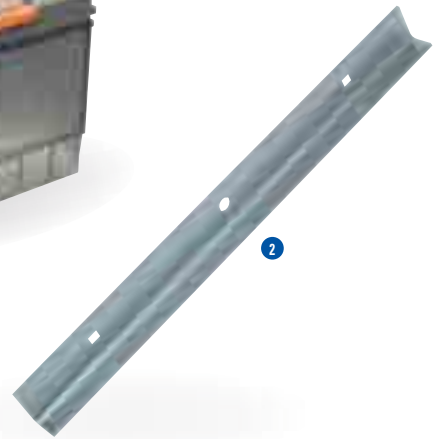

To order see pages 4&5 for distributor details or call 0845 4082 505. Prices available on separate Spares Pricelist

To order see pages 4&5 for distributor details or call 0845 4082 505. Prices available on separate Spares Pricelist



FOR MANUAL PUMP

- 1 P11305 Pump. Hand pump used on Tipping trailer TT85.
- P11415H Pump Handle. For the TT85 tipper trailer (manual pump).
- 2 P11306 Socket Casting. Receiver for pump handle.
- 3 P11308 Filler Cap. For both hand pumps.
- 4 P11309 Release Valve. For both hand pumps.



- 5 P1131 Hydraulic Ram. Hydraulic lifting ram for TT85 Tipping trailers.
- 6 P11310 Hydraulic Ram. Hydraulic lifting ram for the TT105G & TT1126G trailers.
- 7 P1139 Hydraulic Ram. For the CT166 and CT167 models (2 required per trailer).
- 8 P11311 Seal Kit. For TT105 hydraulic ram. (P11310)
- P11312 Seal Kit. For TT85 hydraulic ram (P1131)



Model Specific - Commercial Tipper Range, Hydraulic Power Pack

P11974 Hydraulic Power pack has been fitted on the TT85G since 10/12/06 TT105G & TT126G since 19/03/07

Ifor Williams
Parts®

Page
125

To order see pages 4&5 for distributor details or call 0845 4082 505. Prices available on separate Spares Pricelist



SPARES FOR FENNER/SPX HYDRAULIC POWER PACKS

- 1 P11972 Controller. Hand controller and weatherproof plug.
- 2 P119714 Solenoid. For the Fenner/SPX Hydraulic power units.
- 3 P119722 Pump Handle. For the manual pump section.
- 4 P119715 Release Solenoid. For the release valve.
- 5 P1244 End Plug. Round blanking plug.
- 6 P119724 Manual Release Screw. Including seal.
- 7 P119716 Hand Pump Cartridge. For the manual pump section.
- 8 P119713 Filler Cap. Incorporating breather.
- 9 P0670 Isolator Switch. Battery isolator switch supplied with one removable key.
- 10 P07255 Aqua Safe Plug and Socket. Waterproof plug and socket used for the interior lamp connector on DP trailers and the handset connection on tippers.
- 11 P0670A Isolator Key. Spare key for isolator switch.
- P119712 Tank. Plastic Reservoir for the Fenner/SPX Hydraulic.
- P119710 Motor. Replacement motor.
- P119720 Release Valve Cartridge.



- 12 P11974 Hydraulic Power Pack. FG525 12v.
- 13 P11974BC Battery Cables.
- 14 P11974SF Suction Filter.
- 15 P11974DD Drive Dog.
- 16 P11974EP 3-Pin Handset Plug.
- 17 P11974ES 3-Pin Handset Socket.
- 18 P11974FC Filler Cap.
- 19 P11974H Pump Handle.
- 20 P11974HH Hydraulic Hose.
- 21 P11974HS Handset & Lead.
- P119745LC Coil for Lowering Valve. For model FG525, not compatible with FG515 alone please change valve complete.
- 22 P119745LV Lowering Valve Complete. Compatible with FG515 & FG525 models.
- P119745LVNC Lowering Valve (no coil). For model FG525, not compatible with FG515 alone please change valve complete.
- 23 P11974M Motor.
- 24 P11974MC Motor Cover.
- 25 P11974MV Manual Lowering Valve.
- 26 P11974P Pump Kit.
- 27 P11974SC Seal Kit (O Rings).
- 28 P11974SS Start Solenoid. Compatible with FG525 & FG515 (when copper strip fitted)
- 29 P11974T Tank Kit.





TAILBOARDS & FITTINGS

KS0230	Tailboard. GD4 Series complete tailboard assembly and fittings.
KS0231	Tailboard. GD5 Series complete tailboard assembly and fittings.
KS0232	Tailboard. GD6 Series complete tailboard assembly and fittings.
AS4992	Tailboard Hinge. RH hinge weld assembly.
AS4993	Tailboard Hinge. LH hinge weld assembly.
1 AS5087	Spring Bolt. Used to secure the tailboard.

RAMPS & FITTINGS

KS8511	Rear Ramp. GD4 series complete rear ramp.
KS8513	Rear Ramp. GD5 series complete ramp.
KS8518	Rear Ramp. GD6 series complete ramp.
2 P1168	Ramp Tension Spring.
3 AS5870	Spring Bolt. Used to secure the ramp.

LADDER RACKS

AS8504	Ladder Rack. GD4 Series – Open framed design.
AS8505	Ladder Rack. GD5 Series – Open framed design.
AS8506	Ladder Rack. GD6 Series – Open framed design.

BODY PANEL & LIGHT BRACKETS

C11080	Front Panel. GD4.
C11081	Front Panel. GD5.
C11082	Front Panel. GD6.
C11070	Right Hand Side Panel. GD64.
C11071	Left Hand Side Panel. GD64.
C11072	Right Hand Side Panel. GD84/85.
C11073	Left Hand Side Panel. GD84/85.
C11074	Right Hand Side Panel. GD105/106.
C11075	Left Hand Side Panel. GD105/106.
C11076	Right Hand Side Panel. GD125/126.
C11077	Left Hand Side Panel. GD125/126.
4 AS4990	Light Bracket. Right hand Imperial.
AS4991	Light Bracket. Left hand Imperial.
AS4994	Front Corner Bracket. Right hand GD Imperial.
AS4995	Front Corner Bracket. Left hand GD Imperial.



MESH SIDE COMPONENTS

AS8530	Mesh Side Panel. GD64 Right hand mesh panel.
AS8531	Mesh Side Panel. GD64 Left hand mesh panel.
AS8532	Mesh Side Panel. GD84/85 Right hand mesh panel.
AS8533	Mesh Side Panel. GD84/85 Left hand mesh panel.
AS8534	Mesh Side Panel. GD105 Right hand mesh panel.
AS8535	Mesh Side Panel. GD105 Left hand mesh panel.
AS8540	Mesh Side Panel. GD125/126 Right hand mesh panel.
AS8541	Mesh Side Panel. GD125/126 Left hand mesh panel.
AS8550	Ladder Rack. GD4 Series – Incorporating mesh panel.
AS8551	Ladder Rack. GD5 Series – Incorporating mesh panel.
AS8552	Ladder Rack. GD6 Series – Incorporating mesh panel.
AS8547	Mesh Rear Panel. GD4 Series, used with mesh sides, the rear panel fits over the tailboard.
AS8546	Mesh Rear Panel. GD5 Series, used with mesh sides, the rear panel fits over the tailboard.
AS8549	Mesh Rear Panel. GD6 Series, used with mesh sides, the rear panel fits over the tailboard.









MESH SIDE KITS

KX8530A	Mesh Side Kit. GD64 trailers fitted with a tailboard.
KX8530	Mesh Side Kit. GD64 trailers fitted with a ramp.
KX8532A	Mesh Side Kit. GD84 trailers fitted with a tailboard.
KX8532	Mesh Side Kit. GD84 trailers fitted with a ramp.
KX8533A	Mesh Side Kit. GD85 trailers fitted with a tailboard.
KX8533	Mesh Side Kit. GD85 trailers fitted with a ramp.
KX8534A	Mesh Side Kit. GD105 trailers fitted with a tailboard.
KX8534	Mesh Side Kit. GD105 trailers fitted with a ramp.
KX8536A	Mesh Side Kit. GD125 trailers fitted with a tailboard.
KX8536	Mesh Side Kit. GD125 trailers fitted with a ramp.
KX8538A	Mesh Side Kit. GD106 trailers fitted with a tailboard.
KX8538	Mesh Side Kit. GD106 trailers fitted with a ramp.
KX8540A	Mesh Side Kit. GD126 trailers fitted with a tailboard.
KX8540	Mesh Side Kit. GD126 trailers fitted with a ramp.

TAILBOARDS & FITTINGS

	KS3108	Tailboard Kit. GD5 Metric.
	KS3109	Tailboard Kit. GD4 Metric.
	KS3110	Tailboard Kit. GD6 Metric.
	AS5870	Spring Bolt. To secure the GD tailboard.

RAMPS & FITTINGS













	KS3100	Ramp Kit. GD4 Metric.
	KS3101	Ramp Kit. GD5 Metric.
	KS3102	Ramp Kit. GD6 Metric.
	1 C30708	Ramp Fastener Handle.
	2 P1088	Ramp Fastener Eye Bolt.
	3 AS0558	Ramp Hinge Tube.
	4 P1246	Hinge Pivot Bush.
	P1189	Gas Spring.
	P1192	Protective Bellows.
	5 AS0598	Gas Strut Bracket. Lower.
	6 C10640	Gas Strut Bracket. Upper.



LADDER RACKS

	KX0810	Ladder Rack. GD4 - open framed design.
	KX8011	Ladder Rack. GD5 - open framed design.
	KX8012	Ladder Rack. GD6 - open framed design.

















BODY PANELS, LIGHT BRACKETS & PILLARS

	C12101	Front Panel GD4.
	C12100	Front Panel GD5.
	C12095	Front Panel GD6.
	C12108	Right Hand Side Panel GD6.
	C12109	Left Hand Side Panel GD64.
	C12110	Right Hand Side Panel GD84/85.
	C12111	Left Hand Side Panel GD84/85.
	C12112	Right Hand Side Panel GD105/106.
	C12113	Left Hand Side Panel GD105/106.
	C12114	Right Hand Side Panel GD125/126.
	C12115	Left Hand Side Panel GD125/126.
	AS3112	Rear Pillar. Right hand GD Metric.
	AS3113	Rear Pillar. Left hand GD Metric.
	7 AS3114	Light Bracket. Right hand GD Metric.
	AS3115	Light Bracket. Left hand GD Metric.
	AS4994	Front Corner Bracket. Right hand.
	AS4995	Front Corner Bracket. Left hand.

















GD105 with ramp and meshsides

MESH SIDE COMPONENTS

	AS3128	Mesh Side Panel. GD64 Right hand.
	AS3129	Mesh Side Panel. GD64 Left hand.
	AS3130	Mesh Side Panel. GD84/85 Right hand.
	AS3131	Mesh Side Panel. GD84/85 Left hand.
	AS3132	Mesh Side Panel. GD105/106 Right hand.
	AS3133	Mesh Side Panel. GD105/106 Left hand.
	AS3134	Mesh Side Panel. GD125/126 Right hand.
	AS3135	Mesh Side Panel. GD125/126 Left hand.
	AS3122	Ladder Rack. GD4'series - incorporating mesh panel.
	AS3123	Ladder Rack. GD5'series - incorporating mesh panel.
	AS3143	Ladder Rack. GD6'series - incorporating mesh panel.
	AS3124	Mesh Rear Panel. GD4 Series, used with mesh sides, the rear panel fits over the tailboard.
	AS3125	Mesh Rear Panel. GD5 Series, used with mesh sides, the rear panel fits over the tailboard.
	AS3126	Mesh Rear Panel. GD6 Series, used with mesh sides, the rear panel fits over the tailboard.
	C12105	Mesh Side Support. Right hand.
	8 C12106	Mesh Side Support. Left hand.

MESH SIDE KITS

	KX8000A	Mesh Side Kit. GD64 tailboard.
	KX8000	Mesh Side Kit. GD64 ramp.
	KX8002A	Mesh Side Kit. GD84 tailboard.
	KX8002	Mesh Side Kit. GD84 ramp.
	KX8003A	Mesh Side Kit. GD85 tailboard.
	KX8003	Mesh Side Kit. GD85 ramp.
	KX8004A	Mesh Side Kit. GD105 tailboard.
	KX8004	Mesh Side Kit. GD105 ramp.
	KX8006A	Mesh Side Kit. GD125 tailboard.
	KX8006	Mesh Side Kit. GD125 ramp.
	KX8008A	Mesh Side Kit. GD106 tailboard.
	KX8008	Mesh Side Kit. GD106 ramp.
	KX8009A	Mesh Side Kit. GD126 tailboard.
	KX8009	Mesh Side Kit. GD126 ramp.



To order see pages 4&5 for distributor details or call 0845 4082 505. Prices available on separate Spares Pricelist













P6e with tailboard and 145/70R13 tyres



P7e ramp model

P6e & P7e DEDICATED KITS

	KX8635 Mesh Side Kit P6e. Tailboard models, full mesh sides kit also includes mesh rear panel, mesh ladder rack & all mounting hardware required.
	KX8636 Mesh Side Kit P6e. Ramp models, full mesh sides kit also includes mesh ladder rack & all mounting hardware required.
	KX8638 Mesh Side Kit P7e. Tailboard models, full mesh sides kit also includes mesh rear panel, mesh ladder rack & all mounting hardware required.
	KX8639 Mesh Side Kit P7e. Ramp models, full mesh sides kit also includes mesh ladder rack & all mounting hardware required.
	AS8219 Mesh Ladder Rack. P6E & P7E.
	AS8635 Right Hand Side Mesh Panel. P6E.
	AS8636 Left Hand Side Mesh Panel. P6E.
	AS8637 Mesh Panel over Tailboard. P6E & P7E.
	AS8638 Right Hand Side Mesh Panel. P7E.
	AS8639 Left Hand Side Mesh Panel. P7E.

BODY PANELS

C14419 Front Panel. P6E/P7E.
C14423 Right Hand Side Panel. P6E.
C14424 Left Hand Side Panel. P6E.
C14426 Right Hand Side Panel. P7E.
C14427 Left Hand Side Panel. P7E.

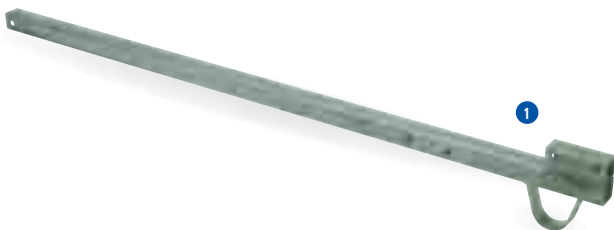

1





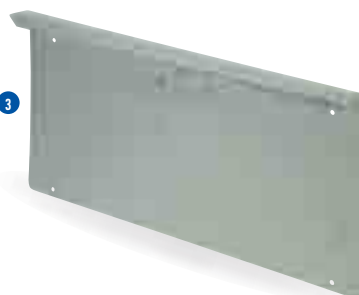









2









3

P6e & P7e COMMON ACCESSORIES

	1 KX0652 ATV Drawbar. Longer straight drawbar to suit lower ATV couplings. Not suitable for the P7E.
	KX8217 Ladder Rack. Open framed design simply slots into the front of P6e and P7e.
	KS8510 Ramp Kit. Replacement standard ramp - ideal for conversions from tailboard.
	KS8509 Stock Ramp. Replacement ramp with small stock door built in (reversible door).
	2 KS0229 Tailboard. Complete tailboard assembly for P6e or P7e models.
	KX0630A Aluminium Canopy Door. Complete with safety glass for P6e & P7e canopies.
	KX0630B Aluminium Canopy Door. Solid panel (no window) for P6e & P7e canopies.
	KX8612 Lamp Guards. Pair of wire mesh guards to fit over the rear lamps.
	P1388 Tarpaulin. Blue elasticated tarpaulin cover tailored to fit the P6e trailer (tailboard models only).
	P1389 Tarpaulin. Blue elasticated tarpaulin cover tailored to fit the P7e trailer (tailboard models only).
	C49505 Treadplate Floor. Hardwearing aluminium floor for P6e.
	C49506 Treadplate Floor. Hardwearing aluminium floor for P7e.

SPARE PARTS

	P0567 Jockey Wheel. Simply replaces the existing front propstand.
	3 C14444 Number Plate Panel. Formed steel panel only.
	AS5106 Spare Wheel Carrier. For P6e & P7e with flotation or 145/70R13 tyres.
	AS5107 Spare Wheel Carrier. For P6e with 145R10 tyres.
	P00355DB Standard P6e Drawbar. Swan neck style drawbar with coupling attached.
	P00355DB2 Standard P7e Drawbar. Swan neck style drawbar with coupling attached.

Model Specific

Unbraked Trailer Range BV64e & P5







BV64e with ramp doors















P5 with P1387 Tarpaulin cover

BV64e MINI BOXVAN

-  **P12014 Roller Shutter Kit.**
- AS4522 Roof Rack Kit.** Incorporates tie-down points for lashing the load (BV64e van door models only, max roof rack weight limit 30kg).
-  **C41611 Treadplate Floor.** Hardwearing aluminium treadplate shaped to fit any BV64e.
- C81616 Rubber Matting.** Grippy rubber matting shaped to fit any BV64e.
- KX0651 Tie Ring Kit.** Pair of internal tie rings (floor mounted, includes fixing bolts).
- P0567 Jockey Wheel.** Simply replaces the existing front propstand.
- AS5875 Propstand.** Replacement galvanised propstand tube (priced each).
- C72160 Mudwing RH.** Moulded plastic wheel arch/wing with cutout for rear lighting.
- C72161 Mudwing LH.** Moulded plastic wheel arch/wing with cutout for rear lighting.
-  **C72162 Roof Moulding.** GRP Moulded roof as used on the roller shutter version.
-  **AS2466 RH Rear Door.** Includes hinges, locking mechanism & exterior locking handle.
-  **AS2467 LH Rear Door.** Includes hinges.
- P1055 Lock Rods.** Internal centre lock mechanism and upper/lower rod set.
- P1054 Chrome Locking Handle.** Used on the rear doors.
- P1070 Hinge.** Used on the rear doors.

P5 RANGE

-  **KX8612 Lamp Guards.** Pair of wire mesh guard to fit over the rear lamps.
-  **KX8613 Front Propstand Kit.** Includes stand, clamp & all mounting hardware required.
-  **KX8614 Treadplate Floor.** Hardwearing aluminium treadplate tailored to fit the P5.
-  **KX8615 Jockey Wheel Kit.** Includes jockey wheel, clamp & all mounting hardware.
-  **KX8616 Ladder Rack Kit.** Includes corner sockets & all mounting hardware required.
-  **KX8626 Mesh Ladder Rack Kit.** Includes corner sockets & all mounting hardware.
-  **KX8627 Mesh Side Kit.** Tailboard models, Full mesh sides kit also includes mesh rear panel, mesh ladder rack, corner sockets & all mounting hardware required.
-  **KX8628 Mesh Side Kit.** Ramp models, Full mesh sides kit also includes mesh ladder rack, corner sockets & all mounting hardware required.
- AS8627 Mesh Side Panel Right Hand or Left Hand Side.** P5.
- AS8629 Mesh Panel over Tailboard.** P5.
- AS8193 Front Corner Socket.** Right hand, needed to secure the ladder rack.
- AS8194 Front Corner Socket.** Left hand, needed to secure the ladder rack.
- KS8610 Tailboard Kit.** P5 Tailboard assembly complete with hinge pins.
-  **KS8611 Ramp Kit.** P5 Ramp assembly complete with hinge pins.
- P1387 Tarpaulin.** Blue elasticated tarpaulin cover (tailboard models only).
-  **P12451 Rope Stud.** Round plastic stud (rivet fixed, rivet not included).
- P00355LDB Standard P5 Drawbar.** Swan neck style drawbar with coupling attached.
-  **KX0652 ATV Drawbar.** Longer straight drawbar to suit lower ATV couplings.
-  **KX0655 GRP Hardtop P5E.**

BODY PANELS

- C14431 Front Panel.**
- C14428 Right Hand Side Panel.**
- C14429 Left Hand Side Panel.**











To order see pages 4&5 for distributor details or call 0845 4082 505. Prices available on separate Spares Pricelist



To order see pages 4&5 for distributor details or call 0845 4082 505. Prices available on separate Spares Pricelist











DEDICATED KITS & COMPONENTS

	KX8641 Mesh Side Kit. Tailboard model, full mesh side kit includes mesh ladder rack, mesh side panels, mesh rear panel & all mounting hardware required.
	KX8642 Mesh Side Kit. Ramp model, full mesh side kit includes mesh ladder rack, mesh side panels & all mounting hardware required.
	AS8647 Mesh Ladder Rack.
	AS8648 Right Hand Side Mesh Panel.
	AS8649 Left Hand Side Mesh Panel.
	AS8650 Mesh Panel over Tailboard.
	P00355DB3 Drawbar Assembly. Swan neck style drawbar with coupling attached.
	AS8252 Rear Frame Weld Assembly.

BODY PANELS

	C14462 Front Panel.
	C14460 Right Hand Side Panel.
	C14461 Left Hand Side Panel.

ACCESSORIES

	KX8218 Ladder Rack. Open framed design.
	KS8613 Ramp Kit. Replacement standard ramp - ideal for conversions from tailboard.
	KS0228 Tailboard. Complete tailboard assembly.
	P0567 Jockey Wheel. 35mm diameter, replaces the front propstand.
	KX0225 Propstand Kit. 1 pair of propstand legs, brackets and fittings.
	C49510 Treadplate Floor. Hardwearing aluminium floor.
	KX0651 Light Duty Lashing Point. Supplied as a pair, ideal for use in all unbraked trailers.
	KX8612 Lamp Guards. Pair of wire mesh guards to fit over the rear lamps.



Model Specific

CT177 Car Transporter

CT177 Mk1 or Mk2?

The Mk1 trailers were beavertailed and had curved cutaways in the loading skids. Mk2 models are totally flat and have squarer skids.



CT177 with GM5 Heavy duty strap winch fitted

ACCESSORIES & SPARES

- P04702** 3T Winch. Three tonne capacity strap winch.
- KS5551** 3T Winch. Three tonne capacity cable winch & angled bracket.
- KX6154** Winch & Power Lead Kit. S4000 Superwinch and all fittings to power from the vehicle battery (6.3m of Red and Black cable included).
- 1 C11752** Winch Mounting Arm. Winch fitting section for CT177. Fitted as standard to the CT177.
- 2 AS3732** Winch Slider Bracket. Allows the optional winch to be moved from side to side to allow for variation in vehicle eye towing position. Fitted as standard to the CT177.
- 3 KX6155** Winch, Bracket & Battery Kit. S4000 Superwinch, battery and mounting bracket & all fittings. Not suitable for use with the Ski Jump Kit.
- 4 KX0241** Wheel Chocks. Spring loaded clip-in wheel chocks (LH / RH pair).
- 5 KX5550** Centre Decking. Provides a safe walk on platform as an alternative to the open centre. Covers ¾ of the trailer bed. Load rating of 300kg per square metre. The kit includes 2 infill walkways, support brackets and all fittings.
- 6 KX5552** Ski-Jump Kit. Special loading skid set that allows the vehicle to be loaded onto a flatbed truck by driving over the CT177. The Ski Jumps are bolted to the front of the trailer main pressways. Supplementary skids which come as part of the kit are stowed in the centre of the trailer, then hook onto the front of the ski jumps and rest on the rear of the truck. The kit includes a two position winch mounting bracket that allows the winch to be lowered quickly and easily when a vehicle is driven over. This kit will not fit the Mk 1 version.
- 7 P1042** Heavy Duty Wheel Securing Strap. Incorporating soft link to avoid damage to alloy wheels.

For more information
on the winch range,
please see pages
56 - 63



To order see pages 4&5 for distributor details or call 0845 4082 505. Prices available on separate Spares Pricelist

To order see pages 4&5 for distributor details or call 0845 4082 505. Prices available on separate Spares Pricelist

UNIQUE SPARE PARTS

- 1 AS3723 **Mini-skid Assy LH.** Pull out mini skid as fitted to CT177 Mk1 models.
- AS3724 **Mini-skid Assy RH.** Pull out mini skid as fitted to CT177 Mk1 models.
- 2 AS3729 **Skid Assembly.** Pull out skid as fitted to CT177 Mk2 models (fits either side). Sold individually.
- AS3705 **Drawbar Set.** Complete replacement weld assembly.
- AS3711 **Centre Suspension Shackle.** Right hand.
- AS3712 **Centre Suspension Shackle.** Left hand.
- 3 KS3715 **Fold Out Adjustable Rear Light Mounting Bracket.** Right hand. For use with Aspock light units, fitted till March 2008.
- KS3716 **Fold Out Adjustable Rear Light Mounting Bracket.** Left hand. For use with Aspock light units, fitted till March 2008.
- 4 AS3737 **Fold Out Adjustable Rear Light Mounting Bracket.** Right hand. For use with Rubolite lamp units, fitted since March 2008.
- AS3736 **Fold Out Adjustable Rear Light Mounting Bracket.** Left hand. For use with Rubolite lamp units, fitted since March 2008.
- 5 KS3722 **Toolbox & Spare Wheel Mounting.** Suitable for all models of CT177.
- C11707 **Number Plate Mount.** Pressed steel panel as fitted to CT177 Mk1 models.
- C11746 **Number Plate Mount.** Pressed steel panel as fitted to CT177 Mk2 models.
- 6 P1087 **Body Clamp.** Over centre clamp secures body to drawbar.
- 7 AS3713 **Hook & Plate.** For over centre body clamp.
- C01705 **Drawbar Pivot Bolt.** Specially shaped M24 bolt unique to the CT177.
- F1066Z **M24 Nut.** To suit drawbar pivot bolt.
- C01706 **Jockey Wheel Clamp Handle.** Longer version unique to CT177.
- F0380Z **Spare Wheel Fitting Bolt.** Long M12 bolt fitted through wheel into well.
- C70694 **Spare Wheel Locating Bush.** Shaped nylon washer fitted under long M12 bolt.

HYDRAULICS

- 8 P11415 **Pump.** Hand pump used on the CT166, CT167 & CT177.
- P11415H **Pump Handle.**
- 9 P11317 **Hydraulic Ram.** For the CT177 model.

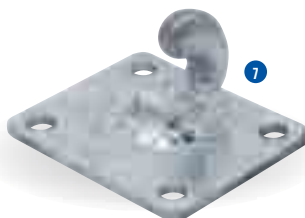
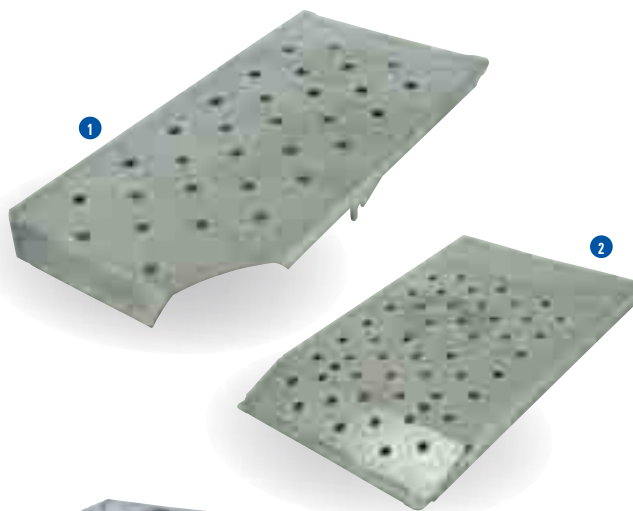







Model Specific

CT136 & CT115 Car Transporter



CT136 Twin axle model

ACCESSORIES & OPTIONS

-  **P04705 Winch "Circuit"**. 600Kg rated mechanical cable winch.
- P04706 Winch "Rally"**. 1050Kg rated mechanical cable winch.
- P04707 Winch "Recovery"**. 1500Kg rated mechanical cable winch.
- 1 KX5528 Winch Mounting Kit**. CT136 & CT136HD Required to fit the winch options above. Mounting bar and winch mounting bracket allows winch to be fitted in the left or right hand mounting positions.
- KX5525 Winch Mounting Kit**. CT115. Required to fit the winch options above. Mounting bar and winch mounting bracket allows winch to be fitted in the left or right hand mounting positions.
-  **2 KX5536 Aluminium Treadplate Infill Kit**. CT136, CT136HD. Provides a safe walk on platform as an alternative to the open centre. The kit includes a front and rear deck infill and all fittings.
-  **3 K55334 Tyre Rack Cranked Bar**. CT136, CT136HD Mounted to the front of this trailer this adjustable rack can accommodate a set of differently sized wheels/tyres. Maximum difference in tyre diameters of 65mm.
-  **KX5535 Tyre Rack Straight Bar**. CT136, CT136HD. Mounted to the front of the trailer this adjustable rack can accommodate a set of wheels/tyres ranging from 500mm to 650mm in diameter.
-  **KX5522 Tyre Rack Cranked Bar**. CT115. Mounted to the front of this trailer this adjustable rack can accommodate a set of differently sized wheels/tyres. Maximum difference in tyre diameters of 65mm.
-  **KX5523 Tyre Rack Straight Bar**. CT115. Mounted to the front of the trailer this adjustable rack can accommodate a set of wheels/tyres ranging from 500mm to 650mm in diameter.
- P1042 Heavy Duty Wheel Securing Straps**. Incorporating soft link to avoid damage to alloy wheels.
- 4 KX0242 Wheel Chocks**. CT136 / CT115. Slide - in front wheel chocks. One pair including fasteners. For vehicles with low ground clearance this feature is invaluable. The wheel stop can be fitted between the wheel and the spoiler after the vehicle is loaded.
- KX0243 Spare Wheel Kit**. For all models of CT136 & CT115. The kit includes wheel and tyre, mounting bracket, wheel brace and all fittings.
- 5 KX0235 Toolbox Kit**. CT136, CT115 Heavy duty, lockable, steel toolbox allows wheel straps and tools to be locked away securely.

UNIQUE SPARE PARTS

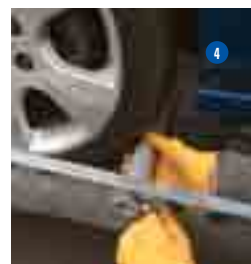
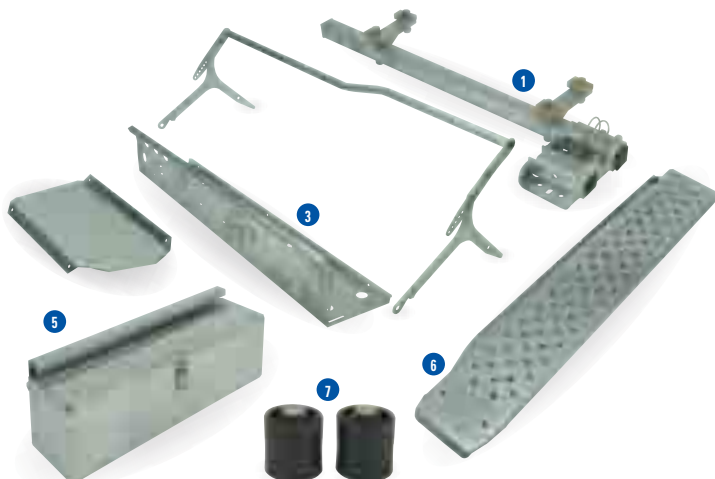

- C11826 Loading Skid**. Left hand replacement loading skid for the CT136 & CT115
- C11852 Loading Skid**. Right hand replacement skid for the CT136 & CT115.
- 6 C11862 Loading Skid**. Right hand for the CT136HD.
- C11863 Loading Skid**. Left hand for the CT136HD.
- 7 C74810 Skid Stop**. Plastic stop fitted to the end of all skid pressings and trailer beds.
- 8 AS1816 Steady Leg**. Adjustable rear support leg.
-  **KS0251 Drawbar Set**. Left and Right hand side. Suitable for the CT115, CT136 & CT136HD
- AS1810 Suspension Cross Member Set**. CT136, CT136HD.
- AS1821 Suspension Cross Member Set**. CT136SA.
- AS0892 Suspension Cross Member Set**. CT115.
- C11845 Number Plate Panel**. CT136 Fold down number plate/skid flap.
- C11864 Number Plate Panel**. CT136HD Fold down number plate/skid flap.
- C11883 Number Plate Panel**. CT115 Fold down number plate/skid flap.
- C01117 Number Plate Retainer**. Long lynch pin receiver for number plate/skid flap.
- C71730 Mudguard**. Used on all CT136 & CT115 models.
- C11828 Light Bracket**. Right hand CT136 & CT115. Also acts as the right hand cross member support. Compatible with Aspock and Rubolite lamps.
- C11814 Light Bracket**. Left hand CT136 & CT115. Also acts as the left hand cross member support. Compatible with Aspock and Rubolite lamps.
- C11848 Toolbox Lid**. Pressed steel panel only.
- P1086 Toolbox Clamp**. Small over centre clamp secures toolbox lid.
- P1086B Receiver Plate**. For small over centre clamp.



To order see pages 4&5 for distributor details or call 0845 4082 505. Prices available on separate Spares Pricelist

	P1200 Roller Shutter. Roller shutter kit for BV5 series (6' headroom).
	P1201 Roller Shutter. Roller Shutter kit BV85G (5' headroom).
	P12011 Roller Shutter. Roller shutter kit for BV6 series (7' headroom).
	P12014 Roller Shutter. Roller Shutter kit BV64E.
	C10208 Rear Panel. BV126 - rear upper panel (over the roller shutter door).
1	P12453 Slam Latch. Fitted inside the left hand rear door on the BV84 box van trailer, adjustable latching point.
2	P1053 Handle. Locking handle with 180 degree movement between open and closed, 8mm square operating shaft. Supplied with 2 keys. Used on the combined ramp/doors versions of all models. Used up to 01/06 before sliding bolts introduced.
3	P1054 Chrome Lever Handle. Used on the rear van door versions of all models. Supplied with two keys.
4	P10580 Inspection Door Handle. Push button handle supplied with two keys. Used on BV4 & BV5 models.
5	P1059 Inspection Door Internal Latch Mechanism.
6	C31275 Cast Lever Handle. Used on BV5 7' headroom & BV6 inspection doors.
7	AS0258 Inspection Door Latch. Used on BV5 7' & BV6 inspection doors.
8	C00049 Sliding Bolt. (Vertical) Spring loaded. Used on models with ramp/doors. 3 per trailer.
	P1173 Compression Spring. Used with the vertical bolt C00049.
9	C40142 Sliding Bolt. (Horizontal). Used on models with ramp/doors 1 per trailer.
10	P1246 Pivot Bush. Used with C40142 sliding bolt. 2 required.
11	P12631 M8 Pin & Knob. Screw into the sliding bolts.
12	C14324 Ramp Closure Handle. Right hand.
	C14325 Ramp Closure Handle. Left hand.
13	C01690 Ramp Closure Lock Pin. Receivers for the ramp handles.

BODY & ROOF PANELS

	C69617 Side Panel. BV84G 1525mm x 2431mm x 14mm.
	C69600 Side Panel. BV85G 1829mm x 2431mm x 14mm.
	C69609 Side Panel. BV85G 7' needs to be cut to size (2134mm x 2431mm).
	C69601 Side Panel. Side panel BV106 6'/BV105 6' 1829mm x 3041mm x 14mm.
	C69610 Side Panel. BV125G 7' & BV126G 7'. Can be cut to size to fit BV105G 7' & BV106G 7'.
	C79305 Opal Roof Sheet. BV84G 2870mm x 1160mm x 1.3mm.
	C79306 Opal Roof Sheet. BV85G 2960mm x 1470mm x 1.3mm.
	C79307 Opal Roof Sheet. BV105G 3570mm x 1470mm x 1.3mm.
	C79308 Opal Roof Sheet. BV106G 4250mm x 1710mm x 1.3mm.



LOAD RESTRAINT

14	P1050 Shoring Pole. BV4 Series, spring loaded pole that fits between the receiver tracks to secure upright loads.
	P1047 Shoring Pole. BV5 Series, spring loaded pole that fits between the receiver tracks to secure upright loads.
	P1048 Shoring Pole. BV6 Series, spring loaded pole that fits between the receiver tracks to secure upright loads.
15	P1035 Receiver Track. Allows for the use of shoring poles 2.40m.
	P1036 Receiver Track. Allows for the use of shoring poles 3.10m.
	P1037 Receiver Track. Allows for the use of shoring poles 3.62m.
16	P1046 Cargo Strap. 3 metre long ratchet cargo strap.
17	KX0202 Lashing Ring Kit. Contains lashing ring, retaining plate, nuts and bolts.
18	KX0224 Propstand Kit. For use on the BV4 & BV5 range. Includes propstand legs, brackets, pads wheel brace and extension and fittings.
19	P0197 PropStand Leg. 590mm long with serrated shaft. Used on the BV6 range.
20	P0209 Clamp Bracket. Complete clamp bracket for the P0197 propstand leg. Used on the BV6 range.

FASTENERS & SEALS

21	F1112ZPK Neoprene Washers. White neoprene washers. Used on the side panels of box vans to retain the receiver tracks. Supplied in packs of 16.
22	F0603WPK Cup Square Bolts. M6 x 25. White headed bolts, used on the side panels of box vans to retain the receiver tracks. Supplied in packs of 20.
23	P1319 Adhesive Foam. 15mm wide and 4mm thick, used on the Inspection doors and rear van doors. Priced per metre.





INSPECTION DOOR KITS

KS2213	Inspection Door Kit. BV84G 5' Headroom. Includes hinges and push button handle.
KS2207	Inspection Door Kit. BV85G & BV105G 6' Headroom. Includes hinges and push button handle.
KS2212/6	Inspection Door Kit. BV106G & BV126G 6' Headroom. Includes hinges and lever handle assembly.
KS2212	Inspection Door Kit. BV106G & BV126G 7' Headroom. Includes hinges and lever handle assembly.

REAR PROTECTION BRACKETS

1 C10308	Rear Protection Bracket RH BV84G.
C10309	Rear Protection Bracket LH BV84G.
C10335	Rear Protection Bracket RH BV85G.
C10336	Rear Protection Bracket LH BV85G.
C10337	Rear Protection Bracket RH BV105G.
C10338	Rear Protection Bracket LH BV105G.
C10364	Rear Protection Bracket RH BV125G.
C10365	Rear Protection Bracket LH BV125G.
C10215	Rear Protection Bracket RH BV106G.
C10216	Rear Protection Bracket LH BV106G.
C10266	Rear Protection Bracket RH BV126G.
C10267	Rear Protection Bracket LH BV126G.





To order see pages 4&5 for distributor details or call 0845 4082 505. Prices available on separate Spares Pricelist

To order see pages 4&5 for distributor details or call 0845 4082 505. Prices available on separate Spares Pricelist

CHASSIS PARTS

	AS0550	Drawbar. 1 pair.
	C10625	Right Hand Front Drawbar Attachment. Also used on the GX106, GX106N & GX126.
	C10626	Left Hand Front Drawbar Attachment. Also used on the GX106, GX106N & GX126.
1	C10355	Bucket Rest Platform.
	C10360	Bucket Rest Support. Right hand.
	C10361	Bucket Rest Support. Left hand.
2	C10559	Rear Cross Member.
3	C10380	Floor Support.
	AS0971	Suspension Cross Member Front.
	AS0972	Suspension Cross Member Middle or Rear.

BODY, FLOOR AND MUDGUARDS

	C695081B	Floor Panel. 18mm x 1250mm x 2425mm.
	C10550	Right Hand Side Panel. Also used on the GX85.
	C10551	Left Hand Side Panel. Also used on the GX85.
	C10554	Front Panel.
	C10555	Right Hand Mudguard. Also used on the GX85.
	C10556	Left Hand Mudguard. Also used on the GX85.
4	C10557	Right Hand Mudguard Cone. Also used on the GX85, GX105, GX105HD, GX106N & GX125HD.
	C10558	Left Hand Mudguard Cone. Also used on the GX85, GX105, GX105HD, GX106N & GX125HD.
	C10564	Mudguard Joining Bracket. 2 per trailer not handed. Also used on the GX85, GX105, GX105HD, GX106N & GX125HD.
5	C10565	Mudguard Side Jointing Plate. 2 per trailer not handed.
6	P1385	Anti Slip Pads. Common to all GX.
7	C70597	Mudflap.
	C10575	Mudflap Fixing Bracket. 2 per trailer. Common to all GX.
8	C10762	Right Hand Light Bracket (Aspock Lights). Also used on the GX105, GX105HD, GX125HD & GX106N.
	C10763	Left Hand Light Bracket (Aspock Lights). Also used on the GX105, GX105HD, GX125HD & GX106N.
	C10635	Right Hand Side Brace Fixing Bracket. Common to all GX.

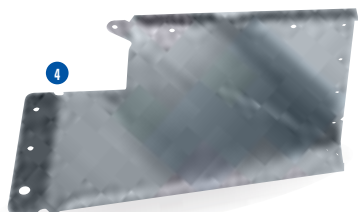
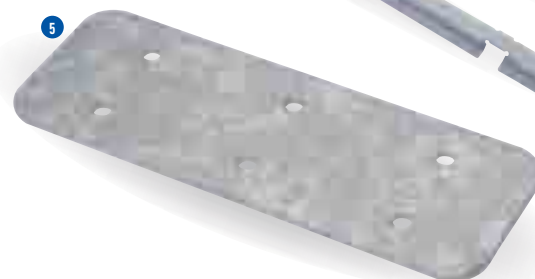
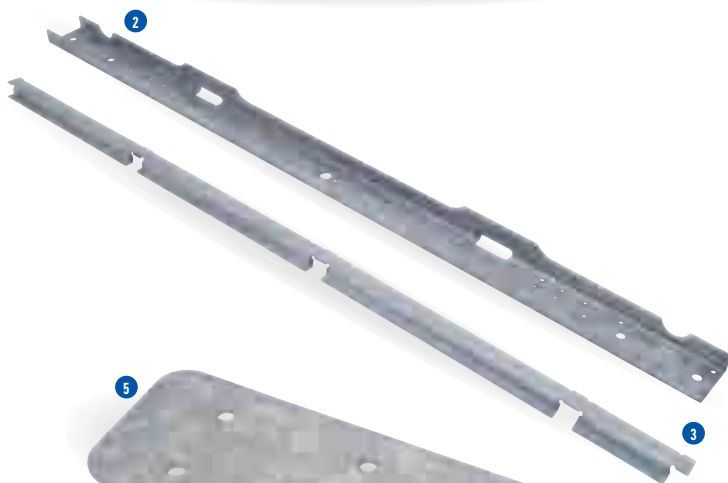

BODY, FLOOR AND MUDGUARDS

- C10636** Left Hand Side Brace Fixing Bracket. Common to all GX.
- 1 C10560** Front Corner Bracket (outer). 2 per trailer not handed common to all GX.
- 2 C10567** Front Corner Bracket (inner). 2 per trailer not handed common to all GX.
- 3 C20550** Front Corner Socket. 2 per trailer not handed common to all GX.

RAMP INSTALLATION

- KS5150** Ramp Installation Kit. Includes hinges and all fittings.
- KS5150/6** Ramp Installation Kit. 6' high. Includes hinges and all fittings.
- AS0568** Right Hand Ramp Hinge Pivot Bracket. Used with ramp and skids - common to all GX except for the GX106 & GX126.
- 4 AS0569** Left Hand Ramp Hinge Pivot Bracket. Used with ramp and skids - common to all GX except for the GX106 & GX126.
- 5 AS0558** Ramp Hinge Tube (not handed). 2 per trailer - common to all GX.
- 6 C10640** Gas Strut Attachment Bracket (top). Common to all GX.
- 7 AS0598** Gas Strut Attachment Bracket (bottom).
- 8 C10707** Rear Corner Pillar. 2 per trailer (not handed) used with ramp and skids - common to all GX.
- 9 C30708** Ramp Fastener Lever Handle. 2 per trailer used with ramp and skids - common to all GX.
- 10 P1088** Ramp Fastener Eye Bolt. 2 per trailer used with ramp and skids - common to all GX.
- 11 P1191** Gas Spring. Assists lifting the rear ramp (2 used on 6' ramps).
- 12 P1192** Protective Bellows.

SKID INSTALLATION

- KS5110** Skid Installation Kit. Includes hinges and fittings.
- KS5110/6** Skid Installation Kit 6'High. Includes hinges and fittings.
- 13 AS0623** Hinge Bracket. 1 per trailer - common to all GX.
- C29414-01725** Steel Hinge Tube.

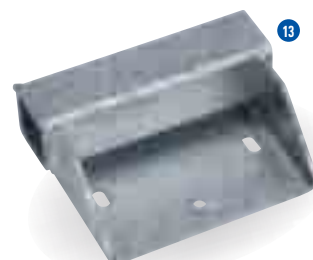
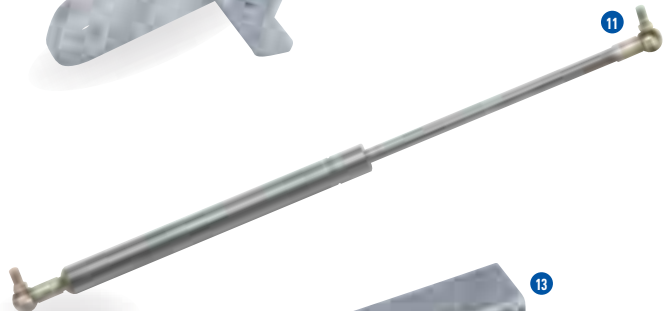
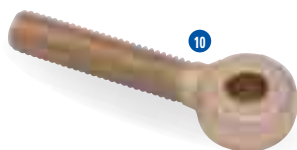
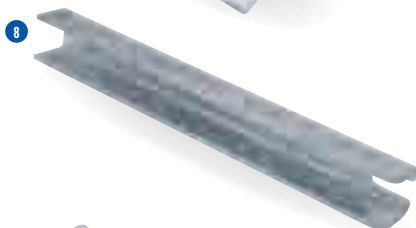
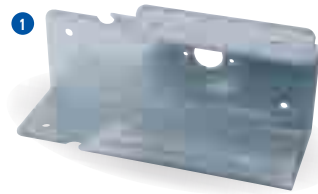

To order see pages 4&5 for distributor details or call 0845 4082 505. Prices available on separate Spares Pricelist



GX106 with skids and integrated rear supports

CHASSIS PARTS GX85

	AS0540 Drawbar. 1 pair.
	C10952 Bucket Rest Platform. Also used on the GX105, GX105HD & GX125HD.
	C10953 Right Hand Bucket Rest Support. Also used on the GX105, GX105HD & GX125HD.
	C10954 Left Hand Bucket Rest Support. Also used on the GX105, GX105HD & GX125HD.
	C10946 Rear Cross Member. Also used on the GX105, GX105HD & GX125HD.
	AS09761 Suspension Cross Member Front. GX85
	AS0978 Suspension Cross Member Rear. GX105, GX105HD
	C10945 Front Panel GX85. Also used on the GX105, GX105HD & GX125HD.



CHASSIS PARTS GX105

	AS0570 Drawbar. 1 pair. Also used on the GX105HD, GX125HD, GX106N, GX106 & GX126.
	C10948 Right Hand Drawbar Attachment Bracket. Also used on the GX105HD & GX125HD.
	C10949 Left Hand Drawbar Attachment Bracket. Also used on the GX105HD & GX125HD.
	AS0976 Suspension Cross Member Front. Also used on the GX105HD.
	AS0977 Suspension Cross Member Middle. Also used on the GX105HD.
	AS0978 Suspension Cross Member Rear. Also used on the GX105HD.
	AS0608 Cross Member Assembly. 2 per trailer also used on the GX105HD & GX125HD.





BODY, FLOOR AND MUDGUARDS

	C69566B Floor Panel. 21mm x 3025mm x 1575mm – used on the GX105 & GX105HD. Cut to size for the GX85.
---	---

RAMP INSTALLATION

	KS5160 Ramp Installation Kit. GX85, GX105, GX105HD & GX125HD. Includes hinges and fittings.
	KS5160/6 Ramp Installation Kit. GX85, GX105, GX105HD & GX125HD. Includes hinges and fittings.

SKID INSTALLATION

	KS5116 Skid Installation Kit. GX85 & GX105. Includes hinges and fittings.
	KS5116/6 Skid Installation Kit. GX85 & GX105 6' high. Includes hinges and fittings.
	C29414-02050 Steel Hinge Tube. Also used on the GX105 & GX105HD.
	KS5117 Skid Installation Kit GX105HD & GX125HD. Includes hinges and fittings.
	KS5117/6 Skid Installation Kit GX105HD & GX125HD. 6' Includes hinges and fittings.



GX106 with skids and integrated rear supports

CHASSIS PARTS GX106

C10359	Bucket Rest Platform. Also used on the GX106N & GX126.
C10627	Right Hand Bucket Rest Support. Also used on the GX106N & GX126.
C10628	Left Hand Bucket Rest Support. Also used on the GX106N & GX126.
C10602	Rear Cross Member. Also used on the GX126.
C10629	Floor Support. Also used on the GX105, GX105HD & GX125HD.
AS0981	Suspension Cross Member Front.
AS0982	Suspension Cross Member Middle.
AS0983	Suspension Cross Member Rear.
AS0571	Cross Member Assembly. 2 per trailer. Also used on the GX126.

CHASSIS PARTS GX106N (UNIQUE TO THIS MODEL)

C10979	Rear Cross Member.
C10975	Front Panel.
AS0996	Suspension Cross Member Front.
AS0997	Suspension Cross Member Middle.
AS0998	Suspension Cross Member Rear.
AS0621	Cross Member Assembly. 2 per trailer.
AS0622	Side Reinforcing Bracket. Also used on the GX105 & GX125HD.

RAMP INSTALLATION GX106 & GX126

KS5180	Ramp Installation Kit. Includes hinges and all fittings.
KS5180/6	Ramp Installation Kit 6' High.
AS0579	Right Hand Ramp Hinge Pivot Bracket. Used with ramp and skids.
AS0580	Left Hand Ramp Hinge Pivot Bracket. Used with ramp and skids.

RAMP INSTALLATION GX106N

KS5170	Ramp Installation Kit. Includes hinges and all fittings.
KS5170/6	Ramp Installation Kit 6'. Includes hinges and all fittings.

BODY, FLOOR AND MUDGUARDS GX106

C69568B	Floor Panel. 21mm x 3025mm x 1840mm - 1 piece.
C10580	Right Hand Side Panel. Also used on the GX105, GX105HD & GX106N.
C10581	Left Hand Side Panel. Also used on the GX105, GX105HD & GX106N.
C10585	Front Panel. Also used on the GX126.
C10586	Right Hand Mudguard.
C10587	Left Hand Mudguard.
C10588	Right Hand Mudguard Cone. Also used on the GX126.
C10589	Left Hand Mudguard Cone. Also used on the GX126.
C10601	Mudguard Joining Plate. 2 per trailer not handed. Also used on the GX126.
C70595	Mudflap. Also used on the GX126.
AS0573	Side Reinforcing Brackets. 2 per trailer not handed.
C10764	Right Hand Light Bracket. (Aspock lights) Also used on the GX126.
C10765	Left Hand Light Bracket. (Aspock lights) Also used on the GX126.

BODY, FLOOR AND MUDGUARDS GX106N (UNIQUE TO THIS MODEL)

C69567B	Floor Panel. 21mm x 3025mm x 1775mm.
C10976	Right Hand Mudguard. Also used on the GX105 & GX105HD.
C10977	Left Hand Mudguard. Also used on the GX105 & GX105HD.

SKID INSTALLATION GX106 & GX126 (ALSO USED ON THE GX126)

KS5130	Skid Installation Kit. Includes hinges and fittings.
KS5130/6	Skid Installation Kit 6' High. Includes hinges and fittings.
C29414-02250	Steel Hinge Tube.

SKID INSTALLATION GX106N

KS5131	Skid Installation Kit. Includes hinges and all fittings.
C29414-02250	Steel Hinge Tube.



GX126 tri-axle with ramp

CHASSIS PARTS GX125HD

AS0661	Drawbar Attachment Cross Member. front.
AS0978	Suspension Cross Member. GX125HD, 4 per trailer.
C10950	Right Hand Drawbar Attachment Bracket.
C10951	Left Hand Drawbar Attachment Bracket.
C10989	Floor Support. Also used on the GX126.

CHASSIS PARTS GX126

AS0906	Suspension Cross Member Front. 2 per trailer.
AS0983	Suspension Cross Member Rear. 2 per trailer.

BODY, FLOOR AND MUDGUARDS GX126

C10985	Right Hand Side Panel. Also used on the GX125HD.
C10986	Left Hand Side Panel. Also used on the GX125HD.
C10960	Right Hand Side Panel. GX126 Tri-axle.
C10961	Left Hand Side Panel. GX126 Tri-axle.
C10987	Right Hand Mudguard.
C10988	Left Hand Mudguard.
C69569B	Floor Panel. 21mm x 3675mm x 1840mm.

BODY, FLOOR AND MUDGUARDS GX125HD

C69570B	Floor Panel. 21mm x 3675mm x 1575mm.
C10982	Right Hand Mudguard.
C10983	Left Hand Mudguard.

GX126 TRI-AXLE CHASSIS PARTS

AS0571	Cross Member Assembly. 3 per trailer.
AS0660	Front Drawbar Attachment Cross Member.
AS0906	Suspension Cross Member Front. 2 per trailer.
AS0983	Suspension Cross Member Rear. 1 per trailer.

MESH SIDE KITS

KX0602	Mesh Side Kit. GX84 Includes mesh ladder rack, Right and Left hand side mesh panels and all fittings.
KX0607	Mesh Side Kit. GX85 Includes mesh ladder rack, Right and Left hand side mesh panels and all fittings.
KX0605	Mesh Side Kit. GX105 Includes mesh ladder rack, Right and Left hand side mesh panels and all fittings.
KX0603	Mesh Side Kit. GX106 Includes mesh ladder rack, Right and Left hand side mesh panels and all fittings.
KX0604	Mesh Side Kit. GX106N Includes mesh ladder rack, Right and Left hand side mesh panels and all fittings.
KX0608	Mesh Side Kit. GX125 Includes mesh ladder rack, Right and Left hand side mesh panels and all fittings.
KX0606	Mesh Side Kit. GX126 Includes mesh ladder rack, Right and Left hand side mesh panels and all fittings.

BOLT ON KNIFE EDGE KITS

(TO REDUCE THE ANGLE BETWEEN RAMP AND FLOOR WHEN LOADING)

KX5100	GX84.
KX5105	GX85, GX105, GX105HD & GX125HD.
KX5110	GX106N.
KX5115	GX106, GX126.

LADDER RACKS

AS0587	GX84. Open framed design.
AS0589	GX85, GX105 & GX125. Open framed design.
AS0591	GX106, GX126. Open framed design.

LASHING LUGS

KS0204	Lashing Lugs. One pair including back plates and fittings. Fitted to the side wall of the GX range. Rated at 500kg per point.
--------	---

Model Specific - GP

GP106, GP106H, GP126, GP126H GP146, GP146H







GP126 tri axle with ramp

To order see pages 4&5 for distributor details or call 0845 4082 505. Prices available on separate Spares Pricelist

ACCESSORIES

Available on the Low sided models only.



	KX1620 Filled in Side Kit. GP106 Available for the low sided models only. Includes 4 lashing rings.
	KX1625 Filled in Side Kit. GP126 Available for the low sided models only. Includes 4 lashing rings.
	KX1630 Filled in Side Kit. GP146 Available for the low sided models only. Includes 4 lashing rings.
	KX1685 Ladder Rack Kit. Suitable for the GP106H, GP126H & GP146H.
	KX1680 Bucket Rest Kit. Suitable for the GP106H, GP126H & GP146H.
	KX0200 Lashing Ring Kit. Includes one recessed lashing ring, securing plate, nuts and bolts.

WINCH OPTIONS

The Ifor Williams 2000kg & 3000kg Mechanical Braked winch can be bolted straight onto the range. Please note it is not possible to fit a winch to the high sided option when the optional bucket rest is fitted.



KX6160	2000kg Manual Winch Kit. Includes the P04685B winch, nuts and bolts to secure.
KX6165	3000kg Manual Winch Kit. Includes the P04680B winch, nuts and bolts to secure.

MESH SIDE KITS (HIGH SIDED MODELS ONLY)

	KX1690 Mesh Side kit. GP106H includes mesh ladder rack, right and left hand side mesh panels.
	KX1691 Mesh Side Kit. GP126H includes mesh ladder rack, right and left hand side mesh panels.

FLOORING







Treadplates

	C49491B Treadplate Floor. GP106 1765mm x 3110mm x 2mm.
	C49490B Treadplate Floor. GP126 1765mm x 3725mm x 2mm.
	C49500 Treadplate Floor. GP146 1765mm x 4340mm x 2mm.

Wooden Floor Panels

	GP106 C69510B. 1525mm x 1774mm x 21mm. Quantity required 2.
	GP126 C69510B. 1525mm x 1774mm x 21mm Quantity required 2. C695102B. 597mm x 1774mm x 21mm Quantity required 1.
	GP146 C69510B. 1525mm x 1774mm x 21mm Quantity required 1. C695672B. 2750mm x 1774mm x 21mm Quantity required 1.

LOADING SKIDS AND FULL WIDTH RAMPS







	KS5135 Loading Skid Kit. For trailers with 155 70 R12 Wheels fitted. All fittings included.
	KS5135/6 Loading Skid Kit. 6' high for trailers with 155 70 R12 Wheels fitted. All fittings included.
	KS5140 Loading Skid Kit. For trailers with 175 75 R16 Wheels fitted. All fittings included.
	KS5140/6 Loading Skid Kit. 6' high for trailers with 175 75 R16 Wheels fitted. All fittings included.
	KS5185 Full Width Ramp. 4' high complete with all fittings.
	KS5185/6 Full Width Ramp. 6' high complete with all fittings.

To order see pages 4&5 for distributor details or call 0845 4082 505. Prices available on separate Spares Pricelist



GH94BT with bevelled ramp



RAMPS AND FITTINGS

	AS2602 4'9" High Ramp. GH64 & GH94.
	AS2591 3'9" Mesh Ramp. GH64 & GH94.
	AS2630 4'9" High Ramp. GH94BT & GH94 + 3.
	AS2631 3'9" Mesh Ramp. GH94BT & GH94 + 3.
	AS2636 4'9" High Ramp. GH1054BT.
	AS2637 3'9" Mesh Ramp. GH1054BT.
1	C12472 Number Plate Panel. Can be used on all ramp variations except for the GH1054
	C12569 Number Plate Panel GH1054.
2	C30708 Ramp Fastener Lever Handle.
3	P1088 Ramp Fastener Eye Bolt.
4	C02501 Ramp Fastener Adjuster.
5	P1159 Tension Spring. To assist in the lowering and raising of the rear ramp. Used on the GH range from March 09 except for the GH94
6	P1163 Tension Spring. To assist in the lowering and raising of the rear ramp GH94.



ACCESSORIES & SPARES

	KX35312 Spare Wheel Kit. Includes wheel assembly 195/55/R10 TL, mounting bracket and fittings. Compatible with the GH64 & GH94.
	KX35318 Spare Wheel Kit. Includes wheel assembly 165R13C, mounting bracket and fittings. Compatible with the GH94BT.
	KX35319 Spare Wheel Kit. Includes wheel assembly 195/55/R10 TL, mounting bracket and fittings. Compatible with the GH94 + 3
	KX35320 Spare Wheel Kit. Includes wheel assembly 185/70/R13, mounting bracket and fittings. Compatible with the GH1054BT.
	KX35311 Winch Kit. Includes P04706 Fulton winch, mounting bracket and fittings. Compatible with all models.
	C80370 Mudflap.
7	KX35327 Coupling Spacer Kit. 48mm, includes 2 aluminium coupling raisers and bolts.
	KX35314 Coupling Spacer Kit. 80mm, includes 2 aluminium coupling raisers and bolts.
8	C72590 LED Side Marker Lamp Bracket.

FLOOR PANELS

	C69591B Ply Floor Panel. 24mm x 1220mm x 2745mm. Used on the GH94 and cut to size for the GH64.
	C69592B Ply Floor Panel. 24mm x 1300mm x 2745mm. Used on the GH94BT (cut to fit) and the GH94 + 3.
	C695675B Ply Floor Panel. 24mm x 1616mm x 2490mm. Used on the GH1054BT.
	C695676B Ply Floor Panel. 1616mm x 465mm. Used on the GH1054BT rear section.

TREADPLATES







	KX35313 Treadplate. GH94 1220mm x 2745mm x 2mm.
	KX35325 Treadplate. GH94BT. Supplied as one formed sheet.
	KX35324 Treadplate. GH1054BT. Supplied as one formed sheet.





EX202-3615 with aluminium drop sides

DROPSIDES, HEADBOARDS & FLOORS

	KX3000 Aluminium Dropside Kit. Dropsides & pillars for EL101-2012.
	KX3020 Aluminium Dropside Kit. Dropsides & pillars for EL101-2512 & EL142-2512.
	KX3030 Aluminium Dropside Kit. Dropsides & pillars for EL101-2515, EL141-2515, EL142-2515 & EX202-2515.
	KX3050 Aluminium Dropside Kit. Dropsides & pillars for EL142-3015 & EX202-3015.
	KX3060 Aluminium Dropside Kit. Dropsides & pillars for EL142-3615 & EX202-3615.
	KX3100 Steel Dropside Kit. Dropsides & pillars for EL101-2012.
	KX3120 Steel Dropside Kit. Dropsides & pillars for EL101-2512 & EL142-2512.
	KX3130 Steel Dropside Kit. Dropsides & pillars for EL101-2515, EL141-2515, EL142-2515 & EX202-2515.
	KX3150 Steel Dropside Kit. Dropsides & pillars for EL142-3015 & EX202-3015.
	KX3160 Steel Dropside Kit. Dropsides & pillars for EL142-3615 & EX202-3615.
	KX3090 Aluminium Headboard Kit. For all 1.2m wide eurolight models.
	KX3091 Aluminium Headboard Kit. For all 1.5m wide eurolight models.
	KX3095 Steel Headboard Kit. For all 1.2m wide eurolight models.
	KX3096 Steel Headboard Kit. For all 1.5m wide eurolight models.
	KX3240 Ladder Rack Kit. For all 1.2m wide eurolight models.
	KX3250 Ladder Rack Kit. For all 1.5m wide eurolight models.
	KX3380 Aluminium Treadplate Floor Kit. For EL101-2012.
	KX3382 Aluminium Treadplate Floor Kit. For EL101-2512 & EL142-2512.
	KX3384 Aluminium Treadplate Floor Kit. For EL101-2515, EL141-2515, EL142-2515 & EX202-2515.
	KX3386 Aluminium Treadplate Floor Kit. For EL142-3015 & EX202-3015.
	KX3388 Aluminium Treadplate Floor Kit. For EL142-3615 & EX202-3615.
	1 KX3185 Propstand Kit. Pair - for all eurolight models.
	KX3190 Lashing Ring Kit. Pair - for all eurolight models.
	2 KX3192 Rope Hook Kit. Pair - extra pair of ropehooks for all eurolight models.
	AS2528 Corner Post. For use with the steel drop side kits, 4 per trailer.
	AS2565 Centre Post. For use with the steel drop side kits, 2 per trailer.
	3 AS2554 Receiver Bracket. For use with the AS2565 centre post.
	AS2529 Corner Post. For use with the aluminium drop side kits, 4 per trailer.
	C72600 Blue Corner Post Capping. For use with the AS2529 corner posts.

MESH SIDES & SKIDS

	KX3350 Mesh Side Kit. Includes all fittings for EL101-2012.
	KX3352 Mesh Side Kit. Includes all fittings for EL101-2512 & EL142-2512.
	KX3362 Mesh Side Kit. Includes all fittings for EL101-2515, EL141-2515, EL142-2515 & EX202-2515.
	KX3364 Mesh Side Kit. Includes all fittings for EL142-3015 & EX202-3015.
	KX3366 Mesh Side Kit. Includes all fittings for EL142-3615 & EX202-3615.
	KX3200 Skid Stowage Kit A. For EL101-2012, EL142-2012, EL142-2515 & EX202-2515. Distributor supply & fit only.
	KX3210 Skid Stowage Kit B. For EL101-2512, EL101-2515, EL141-2515, EL142-3015, EL142-3615, EX202-3015 & EX202-3615. Distributor supply & fit only.
	4 KX3180 2.0m Loading Skid. Pair - for all eurolight models (where skid stowage kit fitted). Load rating of 450kg per skid.



To order see pages 4&5 for distributor details or call 0845 4082 505. Prices available on separate Spares Pricelist

1 KX0379	Mesh Tailgate Kit. Compatible with the Land Rover V379, V381, V382 & V383 canopies.
KX0380	Mesh Tailgate Kit. Compatible with the Land Rover V380, V380C, V386 & V386C canopies.
KX0398	Mesh Tailgate Kit. Compatible with the Mazda/Ranger V387, V388, V389, V387C, V395, V395C, V399, V399C, V388C, V397, V398, V398C & V397C canopies.
KX0404	Mesh Tailgate kit. Compatible with the Mitsubishi/Nissan V401, V405, V405C, V406, V406C, V409, V404, V415, V418, V347, V348, V416, V417, V417C, V305, V345, V346, V424 & V345C canopies.
KX0413	Mesh Tailgate Kit. Compatible with the Mitsubishi L2000 2006 single cab V413 canopy.
KX0419	Mesh Tailgate Kit. Compatible with the Nissan/Toyota V420, V421, V422, V422C, V419, V419C, V469, V4692, V4693, V4694, V469C & V490 canopies.
KX0469	Mesh Tailgate Kit. Compatible with the Toyota 2005/2006 V412, V412C & V4691 canopies.
KX0472	Mesh Tailgate Kit. Compatible with the Mitsubishi V411 & V411C canopies.
KX0379A	Aluminium Door & Window. Compatible with the Land Rover 110 Double Cab V379 canopy.
KX0380A	Aluminium Door & Window. Compatible with the Land Rover 110 Hi Capacity V380 canopy.
KX0381A	Aluminium Door & Window. Compatible with the Land Rover 110 Single Cab V381 canopy.
KX0383A	Aluminium Door & Window. Compatible with the Land Rover 90 Single Cab V383 canopy.
KX0406A	Aluminium Door & Window. Compatible with the Mitsubishi V404, V405, V406 & V406W canopies.
KX0417A	Aluminium Door & Window. Compatible with the Nissan V417, V418, V347 & V348 canopies.
KX0469A	Aluminium Door & Window. Compatible with the Toyota V469, V4692, V4693 & V4694 canopies.
KX04691	Aluminium Door & Window. Compatible with the Toyota Hi- Lux M6 Single Cab V4691 canopy.
KX0472	Aluminium Door & Window. Compatible with the Mitsubishi L200 Double Cab 2006 V411 canopy.
P1214	Safety Glass. Fitted in the rear aluminium doors. 610mm x 305mm.
P1326	Glazing Rubber. Used to secure the safety glass. (Also requires P1327).
P1327	Filler Strip. Holds the safety glass securely within the glazing rubber.
C85000	Rubber Seal. Fits between the canopy and the vehicle body to prevent scratching paint work.
P1003G	Antiluce. Used to secure the mesh and aluminium rear doors.
2 C11899G	Antiluce Plate. Receiver for P1003G.
3 P1023	Cable Clip. Fits into a pre-drilled hole and accepts up to 8mm round cable, many other uses.
4 P1051A	Grab Handle. As fitted to aluminium doors.
5 P1101B	Gudgeon. Weld on receiver for the canopy door hinge.
AS5094	Prop Assembly. To hold open rear canopy doors.
C14737	Rampgate Bracket. P6e RH upper rampgate support bracket fits inside canopy.
C14738	Rampgate Bracket. P6e LH upper rampgate support bracket fits inside canopy.

6 F1401Z	Hook Bolt. M8 x 60mm.
F1402Z	Hook Bolt. M8 x 70mm.
F1404Z	Hook Bolt. M8 x 90mm.
F1409Z	Hook Bolt. M8 x 140mm.
F1089Z	Wing Nut M8. Used with Hook bolts.
KS1120	Canopy Fitting Kit. Includes hook bolts & wing nuts, please specify model of canopy when ordering.
7 P1229	Spring Bolt Receiver. Used within P6e/7e livestock canopies to secure cross divisions.

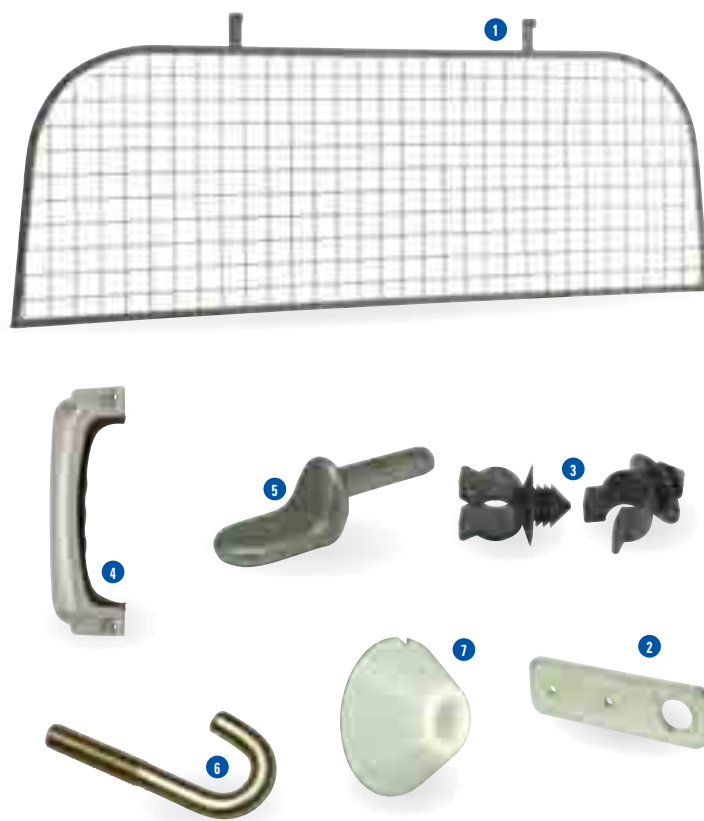

Adding a canopy to an open trailer such as a P6e will greatly increase it's versatility, however if you wish to use it for livestock you will also need ramp side gates and possibly cross divisions too. Our sales department will be happy to advise on canopies to fit your trailer or pickup.